

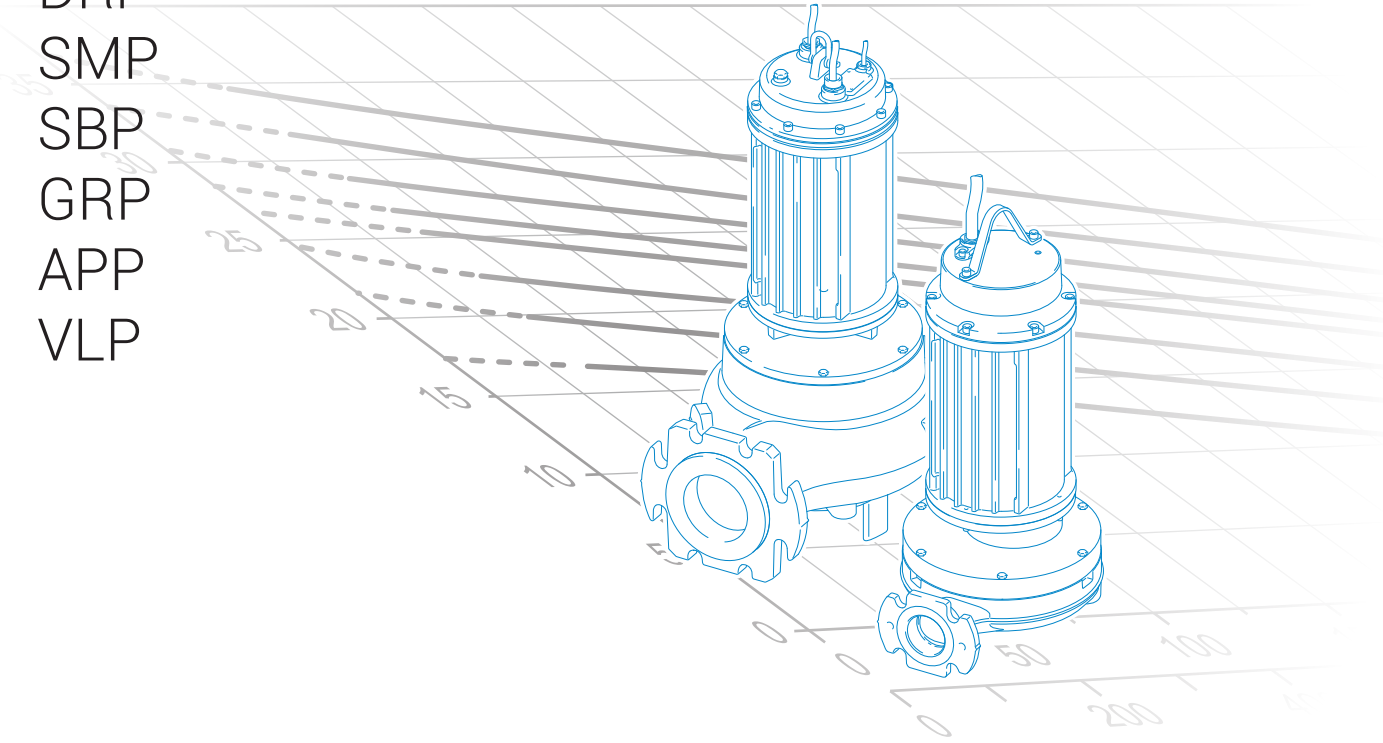

water solutions

P SERIES

- DGP
- DRP
- SMP
- SBP
- GRP
- APP
- VLP





water solutions

P SERIES

DGP

DRP

SMP

SBP

GRP

APP

VLP



D A T A B O O K L E T

P Series

General characteristics

- Constructed in GJL-250 cast iron.
- Shielded ball bearings with lifetime autolubrication.
- Large oil sump to guarantee longer mechanical seal lifetime.
- Oil-bath motor with thermal protections.
- Two mechanical seals in silicon carbide (2SiC) and one mechanical seal in alumina graphite (AL) for maximum reliability even in heavy-duty applications.
- Wide free passage allowing the expulsion of solids and preventing fouling of the impeller.

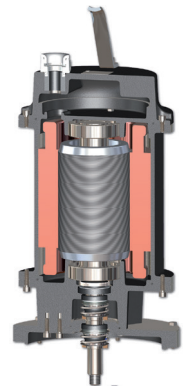

Hydraulic families

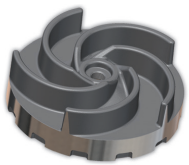

DG (Draga)

- Set-back vortex impeller
- Used with unstrained soiled biological wastewaters and sewage and for civil lifting applications. It is thus ideal for heavy-duty applications in wastewater treatment plants, sewer systems, livestock farms, industry and agriculture.

page 8

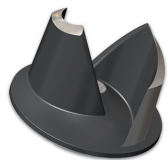

DR (Dreno)

- Multi-channel open impeller
- Designed to transport heavily soiled wastewater, activated sludges and solids. Particularly suitable for applications in wastewater treatment plants, sewer systems, civil lifting systems and the paper, tanning and leather industries.

page 13

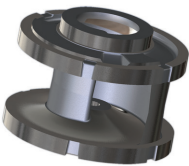

SM (System M)

- Single-channel closed impeller
- Designed for heavy-duty applications, they are generally used in wastewater treatment, residential and sewer plants and for the treatment of wastewater from public establishments. Suitable for pumping industrial sludges.

page 21

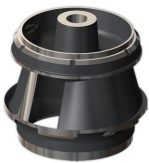

SB (System B)

- Dual-channel closed impeller
- Suitable for heavy-duty industrial applications, they are generally used in civil and industrial wastewater treatment plants, for lifting sewage, for pumping industrial sludges and rainwater containing solids, and for recycling raw or activated sludges and biological liquids.

page 31

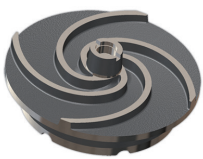

GR (Grinder)

- Impeller with grinder system
- Designed for professional and industrial use, it is suitable for the treatment of liquids containing suspended solids or fibres, and low or medium density activated sludges.

page 37

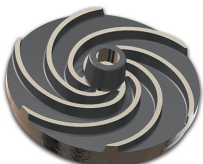

AP (Alta Prevalenza)

- High head impeller
- Used for clear and sandy wastewater, rainwater and seepage. The considerable manometric head guarantees excellent results for the creation of water features and decorative fountains; suitable for use in agriculture, irrigation and the fish processing sector.

page 40



VL (Vulco)

- Multi-channel open impeller with Vulkollan coating
- The special coating on the impeller and hydraulic unit makes this electric pump ideal for transferring ceramic glazes or pumping very dense, strongly abrasive liquids.

page 43

Operating ranges

DGP

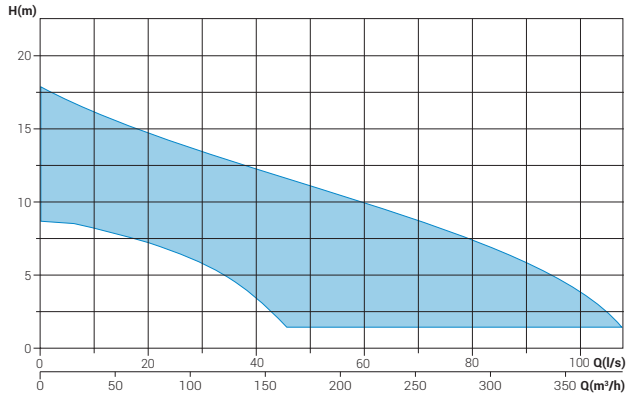

DRP

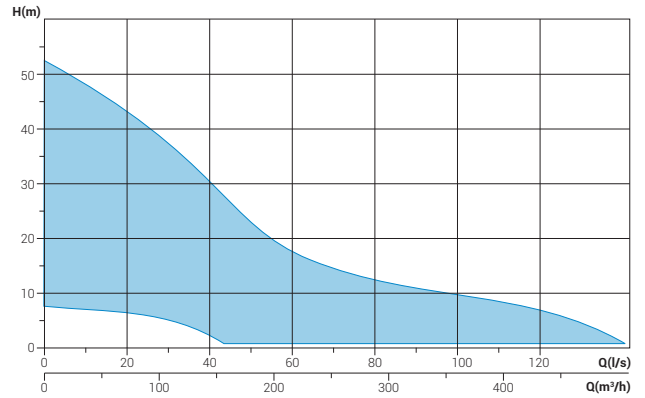

SMP

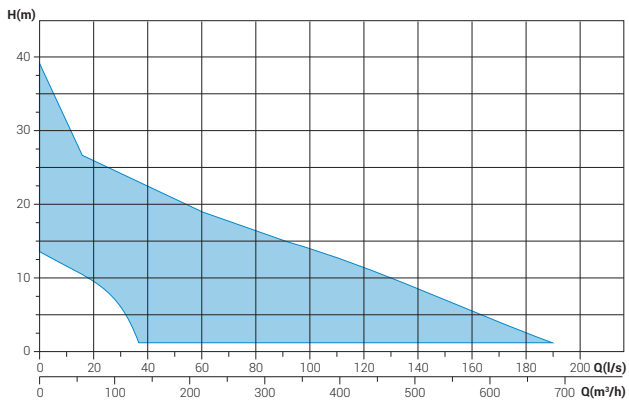

SBP

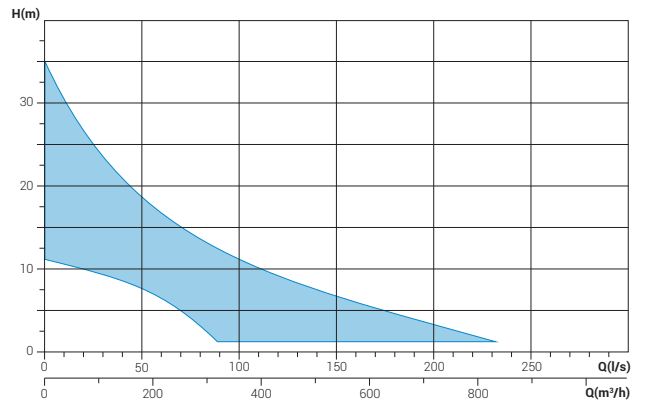

GRP - APP

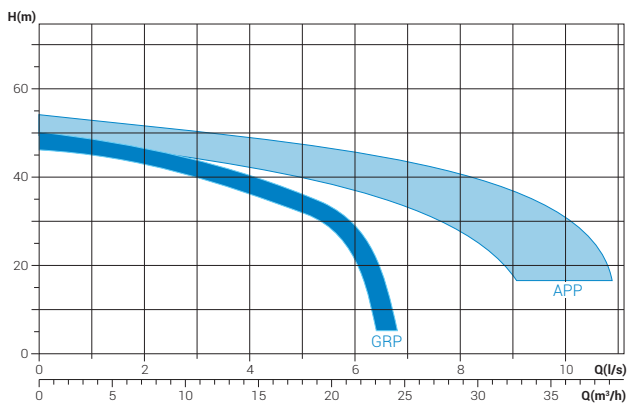

VLP

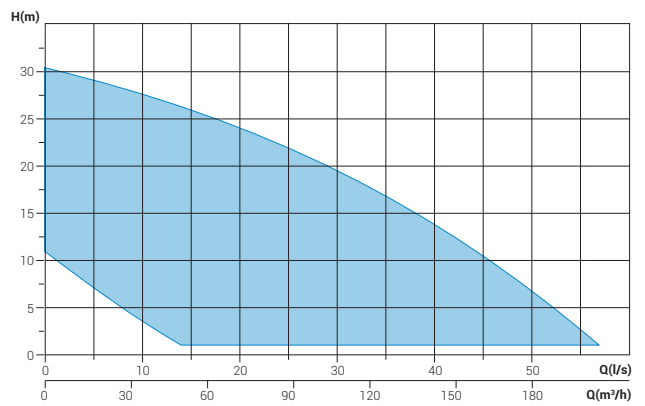

Versions available

• Electrical variants

T	Thermal protection
TS	Thermal protection, sensor for detecting water in the mechanical seal oil sump

• Cooling system

N	No cooling and/or seal flushing system
FT	System for flushing seals with external liquid
CGFT	Cooling jacket and system for flushing seals with external liquid

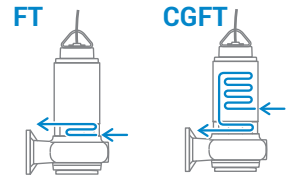

• Set of mechanical seals

2SICAL	2 mechanical seals in silicon carbide + one mechanical seal in
---------------	--

Key to product code

DGP 1000/4/100 A0HT5

① ② ③ ④ ⑤ ⑥ ⑦ ⑧ ⑨ ⑩

① Family	⑦ Version number
② Series	⑧ Motor size
③ Power (HPx100)	⑨ Motor phases M = Single-phase T = Three-phase
④ Motor poles	⑩ Power supply voltage frequency 5 = 50Hz 6 = 60Hz
⑤ Delivery rate	
⑥ Hydraulic model	

Installations

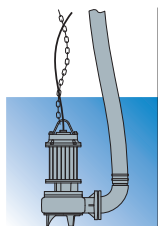

Free installation

The electric pump, standing on its feet or base, is connected to the delivery flexible pipe using a joint fixed to the discharge.

This installation allows to move easily the electrical pump

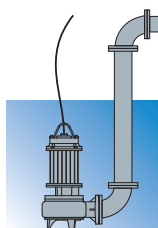

Fixed installation

The electric pump, standing on its feet or base, is connected to the delivery pipe, which is screwed to the discharge if threaded, or fixed to a bend if the port is flanged. The pump-hose connection may be threaded or flanged, depending on the pump fitting.

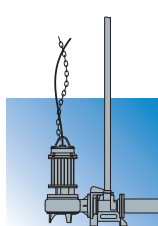
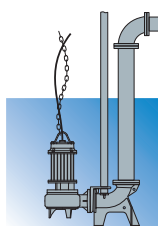

Installation with base coupling foot

Available for electric pumps with threaded discharge. The pump unit is supported by a special device fitted to the delivery pipe. This device can be installed at any time without having to empty the tank. It simplifies any maintenance work on the pump, which can be lifted out and resubmerged with great ease. It is recommended in particular for installations of small size, and does not require the pump to be resting on the bottom of the tank.

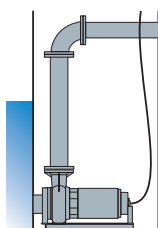
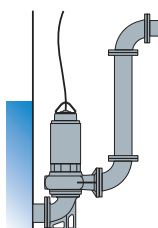

Dry installation with cooling system

For submerged installation, available for electric pumps with flanged or threaded horizontal discharge. The coupling device is fixed to the bottom of the tank and the pump is lowered in with the aid of two guide pipes fitted earlier, until the connection to the foot is completed. The delivery pipe is fixed to the coupling device discharge. This device makes routine checks, any maintenance work or replacement of the pump extremely easy, with no need to empty the tank. A specific kit also allowing pumps with vertical discharge to be installed with the base coupling foot is available.

DGP

Pumps with vortex impeller

Operating ranges

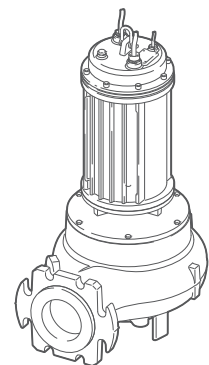
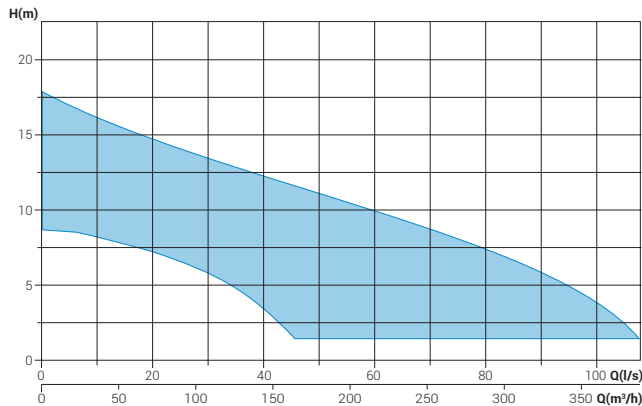

Range characteristics

Motor power	4.6 ÷ 16.4 kW
Poles	2 / 4
Insulation class	H
Degree of protection	IP68
Discharge	DN80 ÷ DN125 horizontal
Free passage	max 102 mm
Max flow rate	101.4 l/s
Max head	17.9 m

Motor

Oil-bath motor with thermal protections.

Cable

S1RN8-F type electrical cable. 10 m standard cable length

Mechanical seals

Two mechanical seals in silicon carbide (2SiC) and one mechanical seal in alumina graphite (AL)

Applications

Used with unstrained soiled biological wastewaters and sewage and for civil lifting applications. It is thus ideal for heavy-duty applications in wastewater treatment plants, sewer systems, livestock farms, industry and agriculture.

Installations

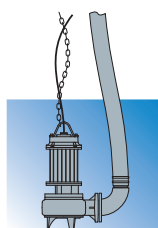

Free

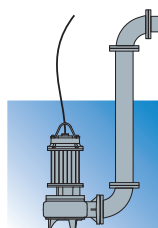

Fixed

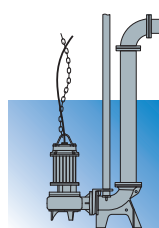

with base coupling foot

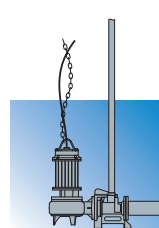

with base coupling foot

Versions

Electrical variants	T, TS
Cooling system	N
Mechanical seals	2SICAL

Operating specifications

Max operating temperature	40 °C
PH of treated fluid	6 ÷ 14
Viscosity of treated fluid	1 mm²/s
Maximum immersion depth	20 m
Density of treated fluid	1 Kg/dm³
Acoustic pressure max	<70dB
Max starts per hour	20

Construction materials

Case	Cast iron EN-GJL 250
Hydraulic parts	Cast iron EN-GJL 250
Impeller	Cast iron EN-GJL 250
Nuts and bolts	Stainless steel - Class A2-70
Standard gasket	Rubber - NBR
Shaft	Stainless steel - AISI 420
Cooling jacket (optional)	Stainless steel - AISI 304
Paint type	Ecological bicomponent epoxy (~ 150 µm)

DGP 4/80

Performances

	l/s	0	4	8	12	16	20	24	28	32	36	40	44	48
	l/min	0	240	480	720	960	1200	1440	1680	1920	2160	2400	2640	2880
	m ³ /h	0	14.4	28.8	43.2	57.6	72	86.4	100.8	115.2	129.6	144	158.4	172.8
① DGP 550/4/80 A0GT5		17.8	11.2	10.6	10.0	9.0	8.0	6.6	5.0	3.3				
② DGP 750/4/80 A0HT5		14.2	13.9	13.5	12.5	11.8	10.6	9.2	7.6	6.0				
③ DGP 1000/4/80 A0HT5		17.1	16.5	16.0	15.4	14.8	14.0	13.5	12.4	11.1	9.8	8.6	7.2	5.5

Characteristic curves according to UNI EN ISO 9906

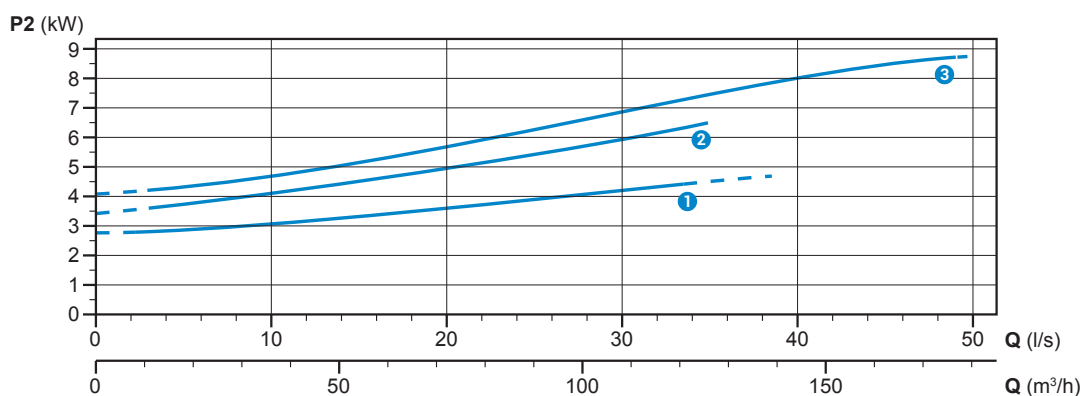
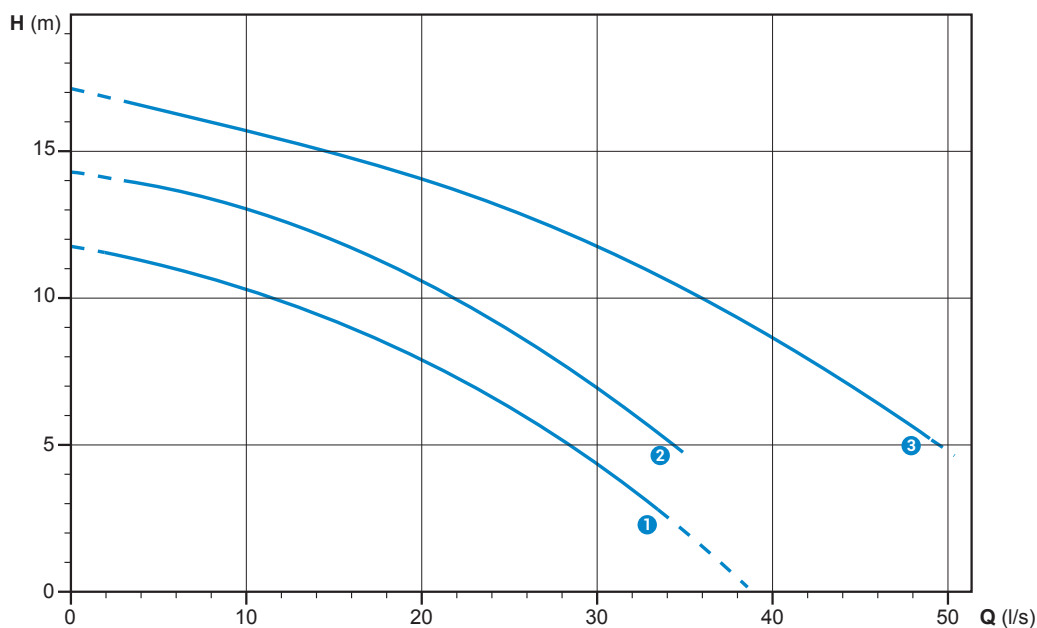

Technical data

	V	Phases	P1 (kW)	P2 (kW)	A	Rpm	Start	Cable	Ø	Free passage
① DGP 550/4/80 A0GT5	400	3	6.0	4.6	10.30	1450	Dir	4G2.5 + 3x1	DN80	60 mm
② DGP 750/4/80 A0HT5	400	3	9.1	7.4	15.82	1450	Y Δ	7G1.5 + 3x0.75	DN80	60 mm
③ DGP 1000/4/80 A0HT5	400	3	12.8	10.45	21.74	1450	Y Δ	7G1.5 + 3x0.75	DN80	60 mm

DGP 4/100

Performances

	l/s	0	5	10	15	20	25	30	35	40	45	50	55	60	65
	l/min	0	300	600	900	1200	1500	1800	2100	2400	2700	3000	3300	3600	3900
	m³/h	0	18	36	54	72	90	108	126	144	162	180	198	216	234
① DGP 550/4/100 A0GT5		10.0	9.5	9.0	8.1	7.2	6.4	5.4	4.2	3.1	1.9				
② DGP 750/4/100 A0HT5		9.6	9.5	9.1	8.5	7.6	6.8	5.9	5.0	4.0	2.8	1.9			
③ DGP 1000/4/100 A0HT5		11.4	11.2	10.9	10.4	9.8	9.0	8.1	7.2	6.1	4.9	3.6			
④ DGP 1500/4/100 A0IT5		16.7	15.8	15.2	14.8	14.1	13.6	12.8	12.0	10.9	9.8	8.8	7.5	6.1	4.1

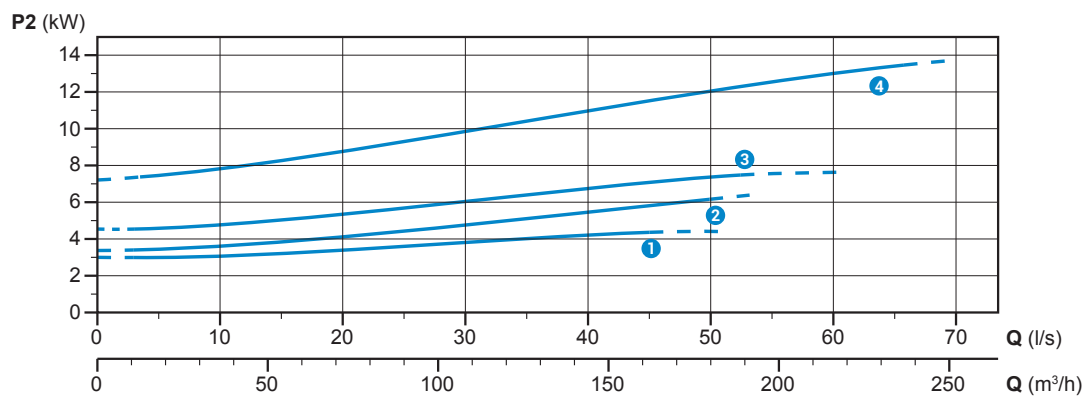
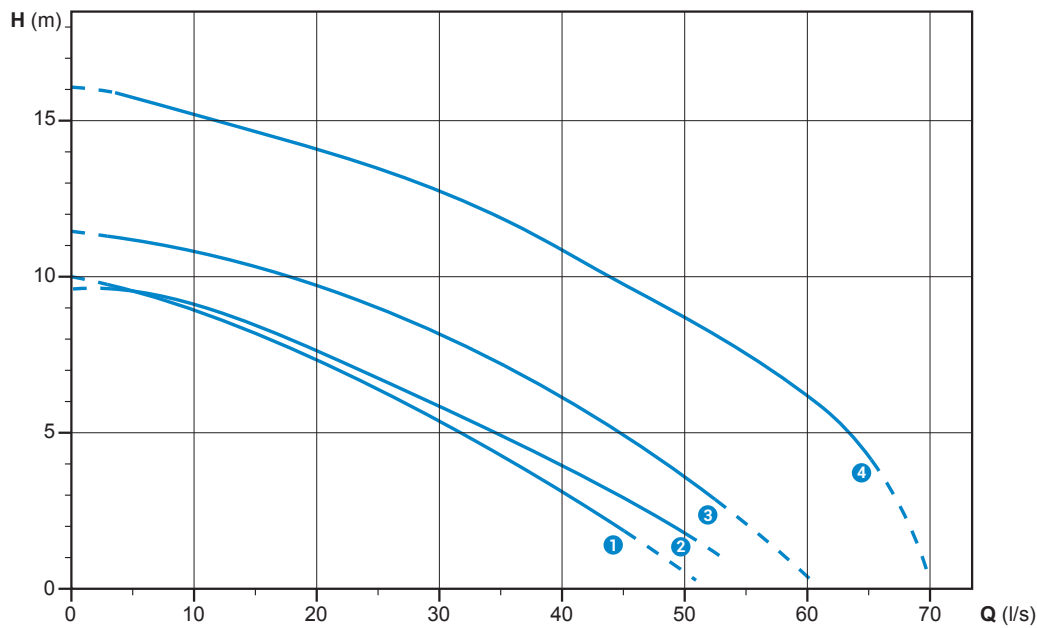

Characteristic curves according to UNI EN ISO 9906

Technical data

	V	Phases	P1 (kW)	P2 (kW)	A	Rpm	Start	Cable	Ø	Free passage
① DGP 550/4/100 A0GT5	400	3	6.0	4.6	10.30	1450	Dir	4G2.5 + 3x1	DN100	80 mm
② DGP 750/4/100 A0HT5	400	3	9.1	7.4	15.82	1450	Y Δ	7G1.5 + 3x0.75	DN100	80 mm
③ DGP 1000/4/100 A0HT5	400	3	12.8	10.45	21.74	1450	Y Δ	7G1.5 + 3x0.75	DN100	85 mm
④ DGP 1500/4/100 A0IT5	400	3	17.5	14.7	31.18	1450	Y Δ	2x 4G6 + 2G1	DN100	80 mm

DGP 4/125

Performances

	l/s	0	8	16	24	32	40	48	56	64	72	80	88	96
	l/min	0	480	960	1440	1920	2400	2880	3360	3840	4320	4800	5280	5760
	m ³ /h	0	28.8	57.6	86.4	115.2	144	172.8	201.6	230.4	259.2	288	316.8	345.6
① DGP 1000/4/125 A0HT5		8.8	8.9	8.8	8.6	8.0	7.0	6.2	5.4	4.2	3.4			
② DGP 1500/4/125 A0IT5		10.2	10.4	10.2	9.9	9.4	8.6	7.8	6.9	6.0	5.0	4.1		
③ DGP 2000/4/125 A0IT5		14.1	14.1	13.9	13.5	13.0	12.1	11.1	10.1	9.0	8.0	7.1	6.0	4.7

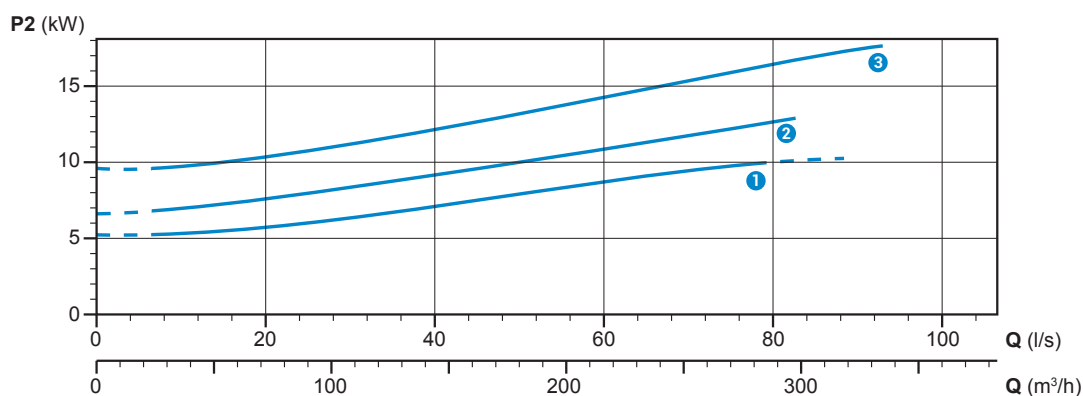
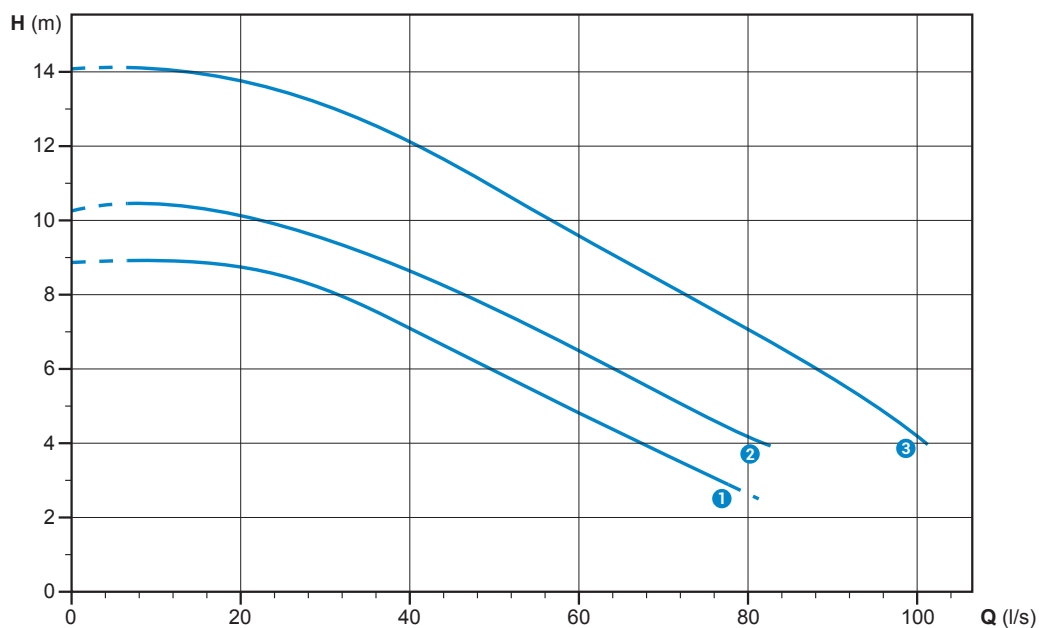

Characteristic curves according to UNI EN ISO 9906

Technical data

	V	Phases	P1 (kW)	P2 (kW)	A	Rpm	Start	Cable	∅	Free passage
① DGP 1000/4/125 A0HT5	400	3	12.8	10.45	21.74	1450	Y Δ	7G1.5 + 3x0.75	DN125	98 mm
② DGP 1500/4/125 A0IT5	400	3	17.5	14.7	31.18	1450	Y Δ	2x 4G6 + 2G1	DN125	102 mm
③ DGP 2000/4/125 A0IT5	400	3	22.5	18.8	39.60	1450	Y Δ	2x 4G6 + 2G1	DN125	102 mm

DGP

Overall dimensions and weights

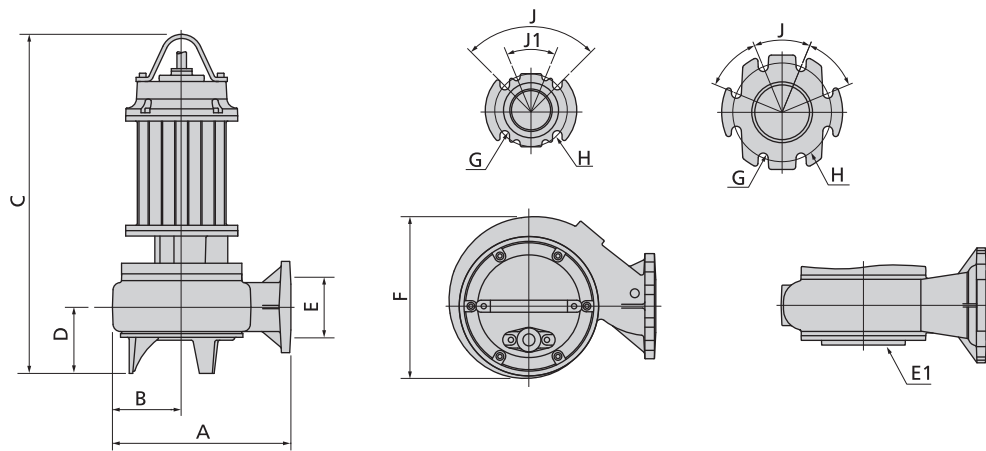

	A	B	C	D	E	E1 (*)	F	G	H	J	J1	kg
DGP 550/4/80 A0GT5	390	150	725	150	80	-	290	18	160	90°	45°	81
DGP 750/4/80 A0HT5	445	175	810	155	80	DN80 PN6	340	18	160	90°	45°	122
DGP 1000/4/80 A0HT5	445	175	810	155	80	DN80 PN6	340	18	160	90°	45°	130
DGP 550/4/100 A0GT5	415	160	740	155	100	-	310	18	180	45°	-	84
DGP 750/4/100 A0HT5	430	165	820	160	100	DN100 PN6	335	18	180	45°	-	115
DGP 1000/4/100 A0HT5	430	165	820	160	100	DN100 PN6	335	18	180	45°	-	125
DGP 1500/4/100 A0IT5	430	165	970	160	100	DN100 PN6	335	18	180	45°	-	165
DGP 1000/4/125 A0HT5	580	280	890	200	125	DN150 PN10	555	18	210	90°	-	180
DGP 1500/4/125 A0IT5	580	280	1010	200	125	DN150 PN10	555	18	210	90°	-	199
DGP 2000/4/125 A0IT5	580	280	1010	200	125	DN150 PN10	555	18	210	90°	-	216

(*) Suction flange available upon request

Dimensions in mm

Packaging dimension



	X	Y	Z
DGP 550/4/80 A0GT5	725	445	415
DGP 750/4/80 A0HT5	915	515	555
DGP 1000/4/80 A0HT5	915	515	555
DGP 550/4/100 A0GT5	725	445	415
DGP 750/4/100 A0HT5	915	515	555
DGP 1000/4/100 A0HT5	915	515	555
DGP 1500/4/100 A0IT5	915	515	555
DGP 1000/4/125 A0HT5	915	515	555
DGP 1500/4/125 A0IT5	1165	720	685
DGP 2000/4/125 A0IT5	1165	720	685

Dimensions in mm

Multi-channel open impeller

Operating ranges

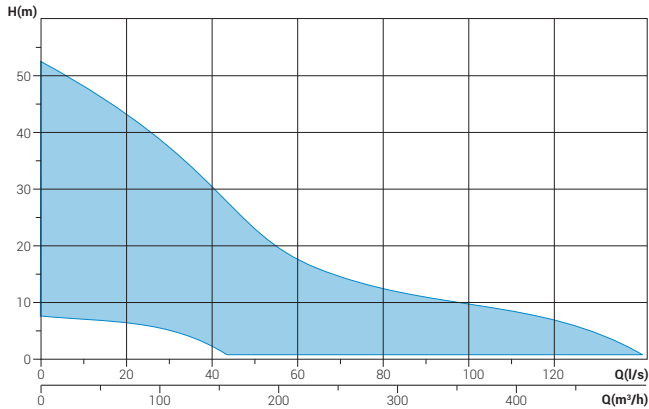

Range characteristics

Motor power	4,1 ÷ 19,3 kW
Poles	2 / 4 / 6
Insulation class	H
Degree of protection	IP68
Discharge	DN80 ÷ DN150 horizontal
Free passage	max 125 mm
Max flow rate	140.9 l/s
Prevalenza max	52.6 m

Motor

Oil-bath motor with thermal protections.

Cable

S1RN8-F type electrical cable. 10 m standard cable length

Mechanical seals

Two mechanical seals in silicon carbide (2SiC) and one mechanical seal in alumina graphite (AL)

Applications

Designed to transport heavily soiled wastewater, activated sludges and solids. Particularly suitable for applications in wastewater treatment plants, sewer systems, civil lifting systems and the paper, tanning and leather industries.

Installations

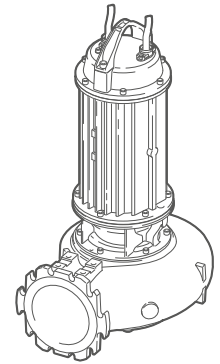
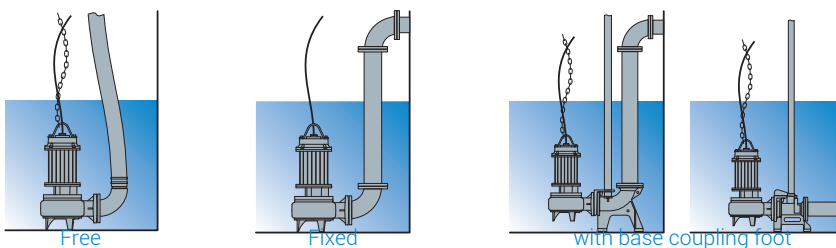

Versions

Electrical variants	T, TS
Cooling system	N
Mechanical seals	2SICAL

Operating specifications

Max operating temperature	40 °C
PH of treated fluid	6 ÷ 14
Viscosity of treated fluid	1 mm²/s
Maximum immersion depth	20 m
Density of treated fluid	1 Kg/dm³
Acoustic pressure max	<70dB
Max starts per hour	20

Construction materials

Case	Cast iron EN-GJL 250
Hydraulic parts	Cast iron EN-GJL 250
Impeller	Cast iron EN-GJL 250
Nuts and bolts	Stainless steel - Class A2-70
Standard gasket	Rubber - NBR
Shaft	Stainless steel - AISI 420
Cooling jacket (optional)	Stainless steel - AISI 304
Paint type	Ecological bicomponent epoxy (~ 150 µm)

DRP 2/80

Performances

	0	4	8	12	16	20	24	28	32	36	40	
l/s	0	240	480	720	960	1200	1440	1680	1920	2160	2400	
l/min	0	14.4	28.8	43.2	57.6	72	86.4	100.8	115.2	129.6	144	
m ³ /h	0	24	22.0	20.8	18.8	16.8	14.5	12.4	10.0	8.0	5.5	3.0
1	DRP 750/2/80 A0HT5	30	28.0	26.0	24.0	21.0	18.8	16.0	12.4			
2	DRP 1000/2/80 A1HT5	40.8	39.0	37.5	36.0	34.0	32.0	29.5	27.0	24.0	21.0	17.0
3	DRP 1500/2/80 A0HT5	48.0	47.0	46.0	44.2	43.0	41.0	39.0	36.0	32.7	28.0	24.0
4	DRP 2000/2/80 A0IT5											

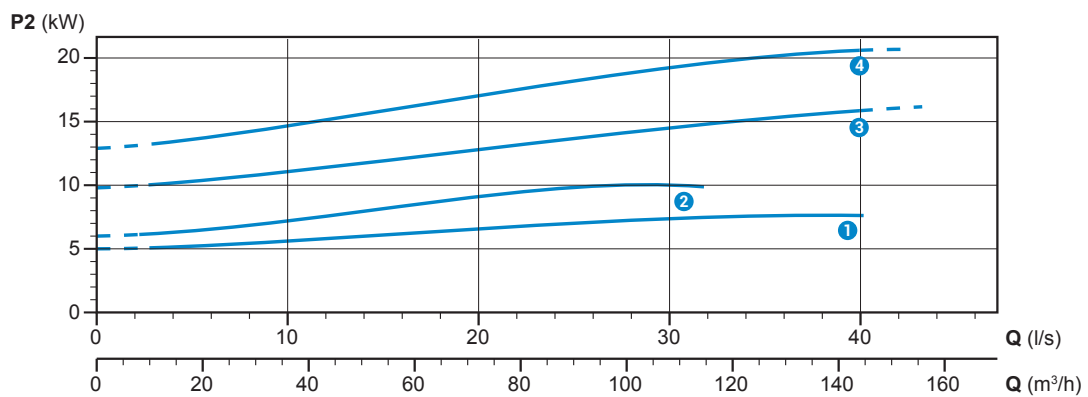
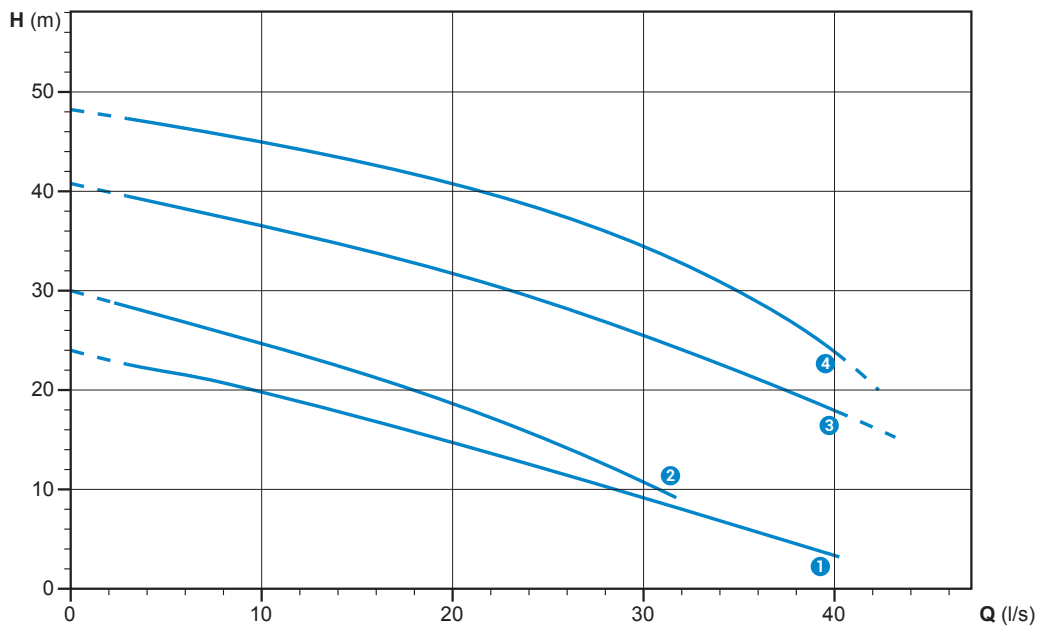

Characteristic curves according to UNI EN ISO 9906

Technical data

	V	Phases	P1 (kW)	P2 (kW)	A	Rpm	Start	Cable	Ø	Free passage	
1	DRP 750/2/80 A0HT5	400	3	10.0	7.9	16.04	2900	Y Δ	7G1.5 + 3x0.75	DN80	65x55 mm
2	DRP 1000/2/80 A1HT5	400	3	13.6	10.8	21.57	2900	Y Δ	7G1.5 + 3x0.75	DN80	65x55 mm
3	DRP 1500/2/80 A0HT5	400	3	19.1	16.3	30.30	2900	Y Δ	7G2.5 + 3x0.75	DN80	60x50 mm
4	DRP 2000/2/80 A0IT5	400	3	23.3	20.6	37.79	2900	Y Δ	2x 4G6 + 2G1	DN80	60x35 mm

DRP 2/100

Performances

	0	10	20	30	40	50	60
l/s	0	10	20	30	40	50	60
l/min	0	600	1200	1800	2400	3000	3600
m ³ /h	0	36	72	108	144	180	216
① DRP 1000/2/100 A1HT5	25.7	22.0	18.1	14.6	10.8	6.5	2.1
② DRP 1500/2/100 A0HT5	34.0	31.0	27.6	24.0	20.1	16.0	10.8

Characteristic curves according to UNI EN ISO 9906

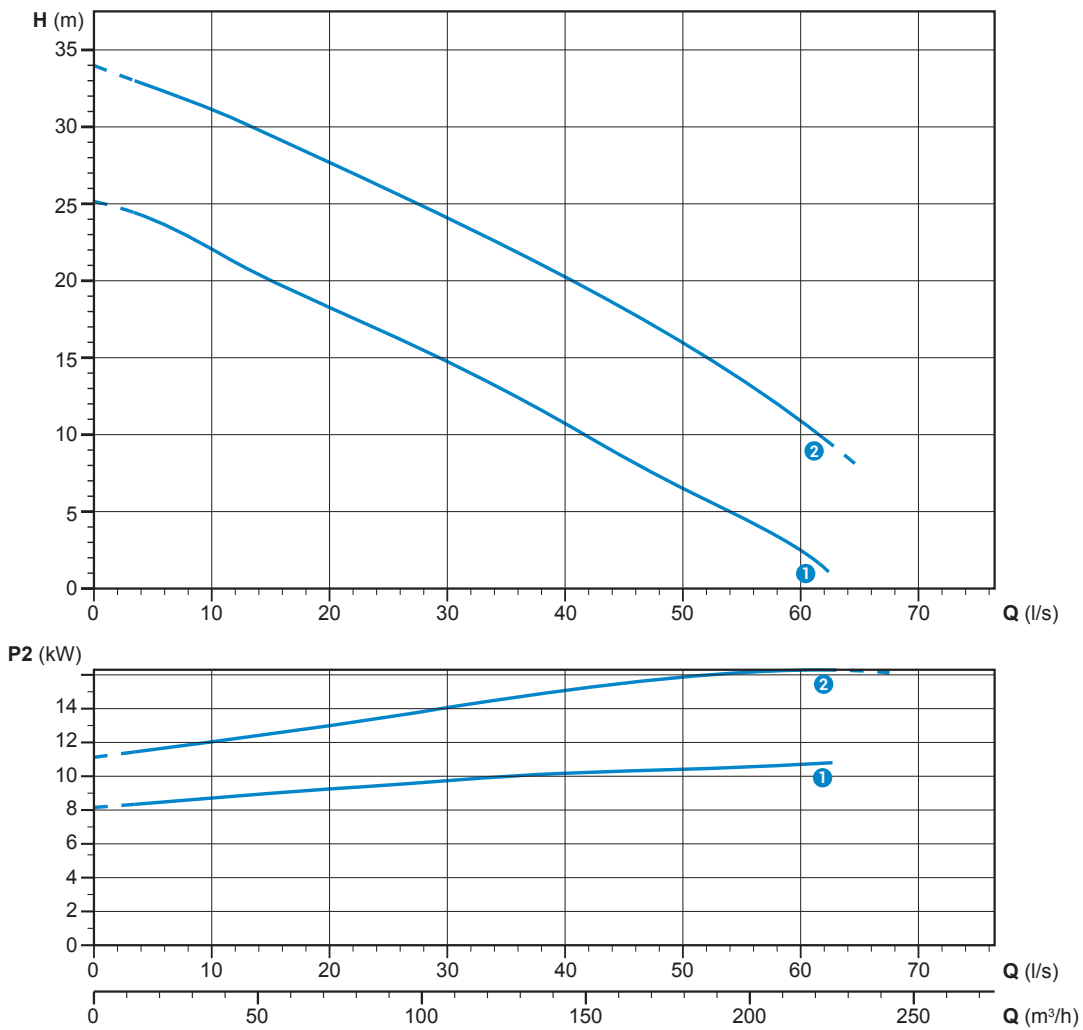

Technical data

	V	Phases	P1 (kW)	P2 (kW)	A	Rpm	Start	Cable	Ø	Free passage
① DRP 1000/2/100 A1HT5	400	3	13.6	10.8	21.57	2900	Y Δ	7G1.5 + 3x0.75	DN100	80x75 mm
② DRP 1500/2/100 A0HT5	400	3	19.1	16.3	30.30	2900	Y Δ	7G2.5 + 3x0.75	DN100	80x70 mm

DRP 4/80

Performances

	l/s	0	4	8	12	16	20	24	28	32	36	40	44	48	52
	l/min	0	240	480	720	960	1200	1440	1680	1920	2160	2400	2640	2880	3120
	m ³ /h	0	14.4	28.8	43.2	57.6	72	86.4	100.8	115.2	129.6	144	158.4	172.8	187.2
①	DRP 550/4/80 A0GT5	14.0	13.0	12.0	11.0	10.0	9.0	7.5	6.0	4.2	3.0	1.0			
②	DRP 750/4/80 A0HT5	18.7	17.8	17.0	16.0	15.1	14.0	13.0	11.8	10.0	8.2	6.5	4.8	3.0	1.0
③	DRP 1000/4/80 A0HT5	23.4	22.3	21.2	20.0	18.9	17.6	16.2	14.6	13.4	11.8	10.0	8.0	6.0	3.6
④	DRP 1500/4/80 A0IT5	29.6	28.3	27.6	27.0	26.2	25.6	24.9	24.0	23.4	22.0	21.0	19.2	17.2	
⑤	DRP 2000/4/80 A0IT5	32.5	31.5	30.4	29.6	28.9	28.0	27.0	25.5	24.0	22.5	20.5	18.0	15.2	

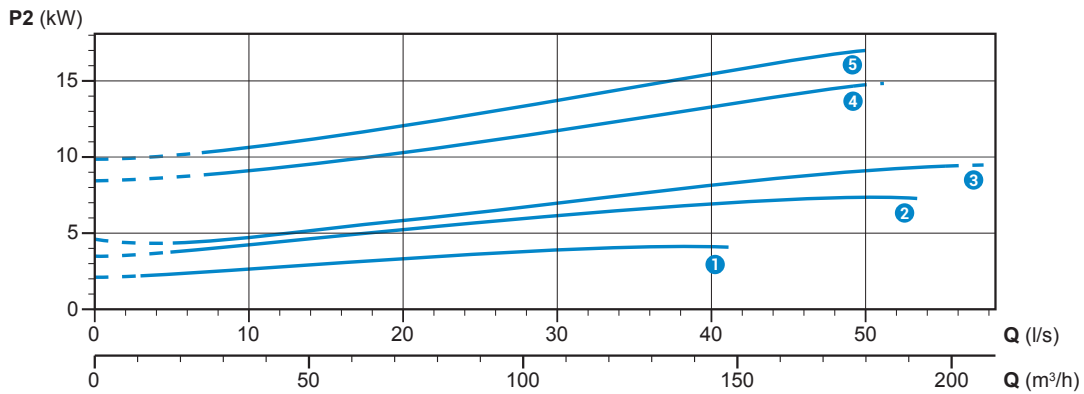
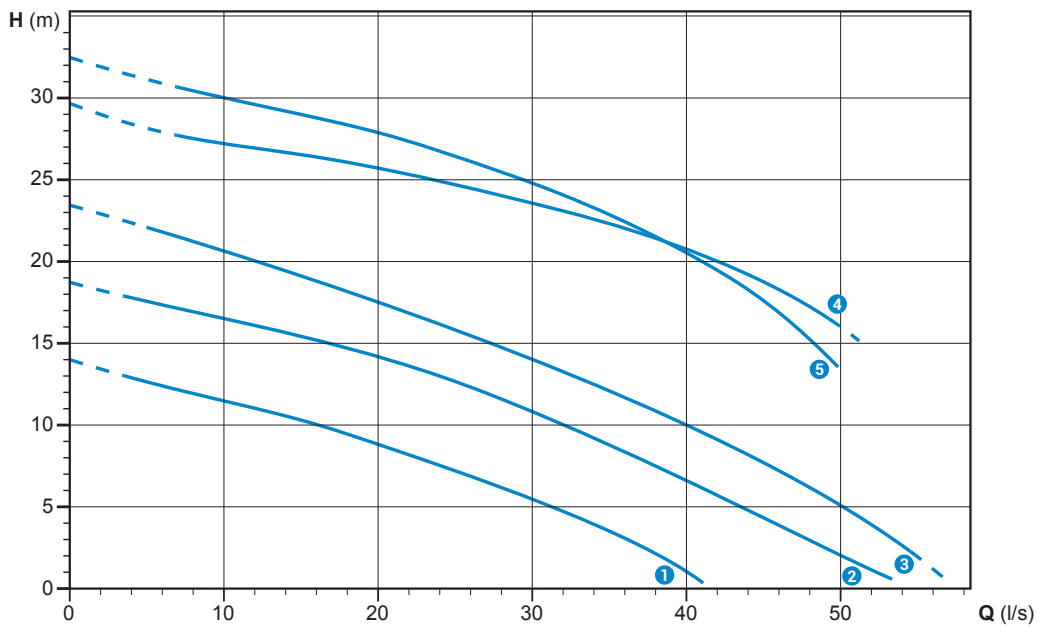

Characteristic curves according to UNI EN ISO 9906

Technical data

	V	Phases	P1 (kW)	P2 (kW)	A	Rpm	Start	Cable	Ø	Free passage	
①	DRP 550/4/80 A0GT5	400	3	6.0	4.6	10.30	1450	Dir	4G2.5 + 3x1	DN80	70x60 mm
②	DRP 750/4/80 A0HT5	400	3	9.1	7.4	15.82	1450	Y Δ	7G1.5 + 3x0.75	DN80	70x60 mm
③	DRP 1000/4/80 A0HT5	400	3	12.8	10.45	21.74	1450	Y Δ	7G1.5 + 3x0.75	DN80	70x60 mm
④	DRP 1500/4/80 A0IT5	400	3	17.5	14.7	31.18	1450	Y Δ	2x 4G6 + 2G1	DN80	70x50 mm
⑤	DRP 2000/4/80 A0IT5	400	3	22.5	18.8	39.60	1450	Y Δ	2x 4G6 + 2G1	DN80	70x50 mm

DRP 4/100

Performances

	l/s	0	10	20	30	40	50	60	70
	l/min	0	600	1200	1800	2400	3000	3600	4200
	m ³ /h	0	36	72	108	144	180	216	252
①	DRP 550/4/100 A0GT5	12.9	11.0	9.0	7.0	4.2	1.5		
②	DRP 750/4/100 A0HT5	16.0	14.4	13.0	11.1	9.0	6.4	3.3	
③	DRP 1000/4/100 A0HT5	19.1	17.8	16.2	14.2	12.0	9.5	6.7	3.5
④	DRP 1500/4/100 A0IT5	21.6	20.5	19.2	17.8	15.8	13.4	10.6	7.5

Characteristic curves according to UNI EN ISO 9906

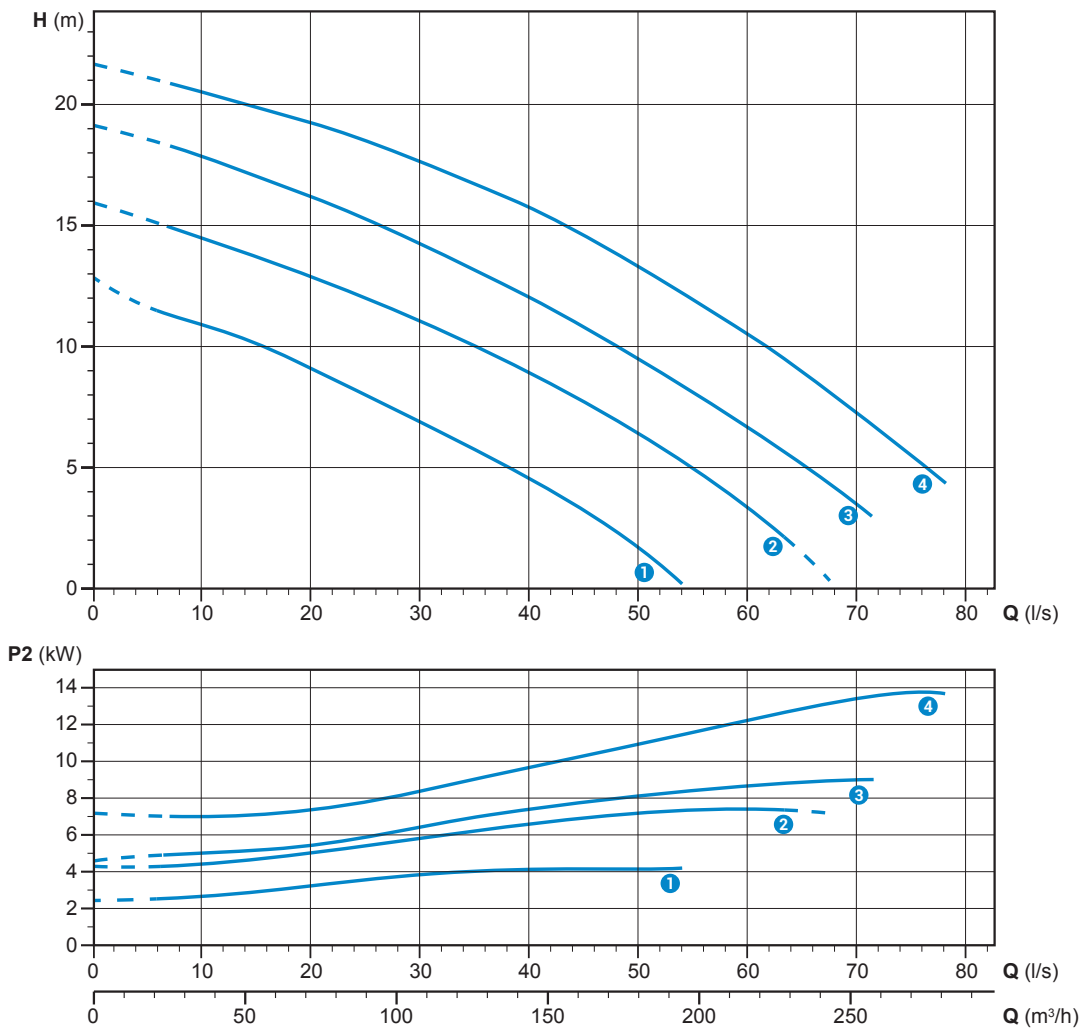

Technical data

	V	Phases	P1 (kW)	P2 (kW)	A	Rpm	Start	Cable	Ø	Free passage	
①	DRP 550/4/100 A0GT5	400	3	6.0	4.6	10.30	1450	Dir	4G2.5 + 3x1	DN100	70x65 mm
②	DRP 750/4/100 A0HT5	400	3	9.1	7.4	15.82	1450	Y Δ	7G1.5 + 3x0.75	DN100	95x85 mm
③	DRP 1000/4/100 A0HT5	400	3	12.8	10.45	21.74	1450	Y Δ	7G1.5 + 3x0.75	DN100	95x80 mm
④	DRP 1500/4/100 A0IT5	400	3	17.5	14.7	31.18	1450	Y Δ	2x 4G6 + 2G1	DN100	95x70 mm

DRP 4/125

Performances

	l/s	0	10	20	30	40	50	60	70	80	90	100	110
	l/min	0	600	1200	1800	2400	3000	3600	4200	4800	5400	6000	6600
	m ³ /h	0	36	72	108	144	180	216	252	288	324	360	396
①	DRP 1500/4/125 A0IT5	18.0	16.9	15.6	14.3	13.0	11.5	10.0	8.4	7.0	5.5	3.8	
②	DRP 2000/4/125 A0IT5	21.5	19.8	18.4	17.0	15.6	14.3	13.0	11.9	10.6	9.3	7.9	6.1

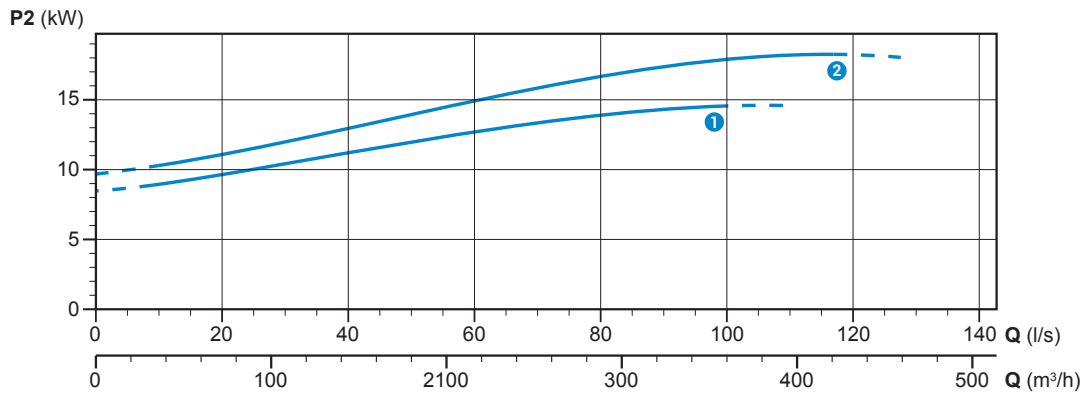
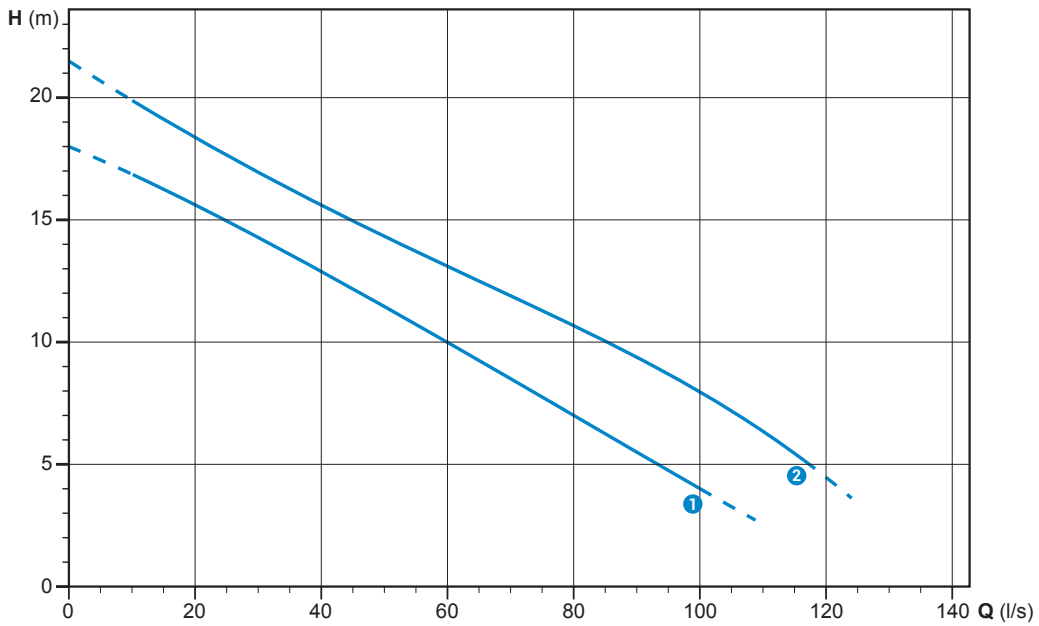

Characteristic curves according to UNI EN ISO 9906

Technical data

	V	Phases	P1 (kW)	P2 (kW)	A	Rpm	Start	Cable	∅	Free passage	
①	DRP 1500/4/125 A0IT5	400	3	17.5	14.7	31.18	1450	Y Δ	2x 4G6 + 2G1	DN125	105x90 mm
②	DRP 2000/4/125 A0IT5	400	3	22.5	18.8	39.60	1450	Y Δ	2x 4G6 + 2G1	DN125	105x90 mm

DRP 4/150

Performances

	0	10	20	30	40	50	60	70	80	90	100	110	120	130	140	
I/s	0	10	20	30	40	50	60	70	80	90	100	110	120	130	140	
l/min	0	600	1200	1800	2400	3000	3600	4200	4800	5400	6000	6600	7200	7800	8400	
m ³ /h	0	36	72	108	144	180	216	252	288	324	360	396	432	468	504	
① DRP 750/4/150 A0HT5	11.7	10.6	9.7	8.9	8.1	7.2	6.2	5.0	3.8	2.4	1.0					
② DRP 1000/4/150 A0HT5	15.0	14.0	12.8	11.9	11.0	10.0	9.0	8.0	6.7	5.4	4.0	2.4				
③ DRP 1500/4/150 A0IT5	15.5	14.5	13.6	12.8	12.2	11.5	10.5	9.5	8.3	7.2	6.0	4.9	3.6	2.0		
④ DRP 2000/4/150 A0IT5	18.0	17.0	16.0	15.0	14.5	13.5	13.0	12.2	11.0	9.7	8.5	7.3	6.0	4.4	2.5	

Characteristic curves according to UNI EN ISO 9906

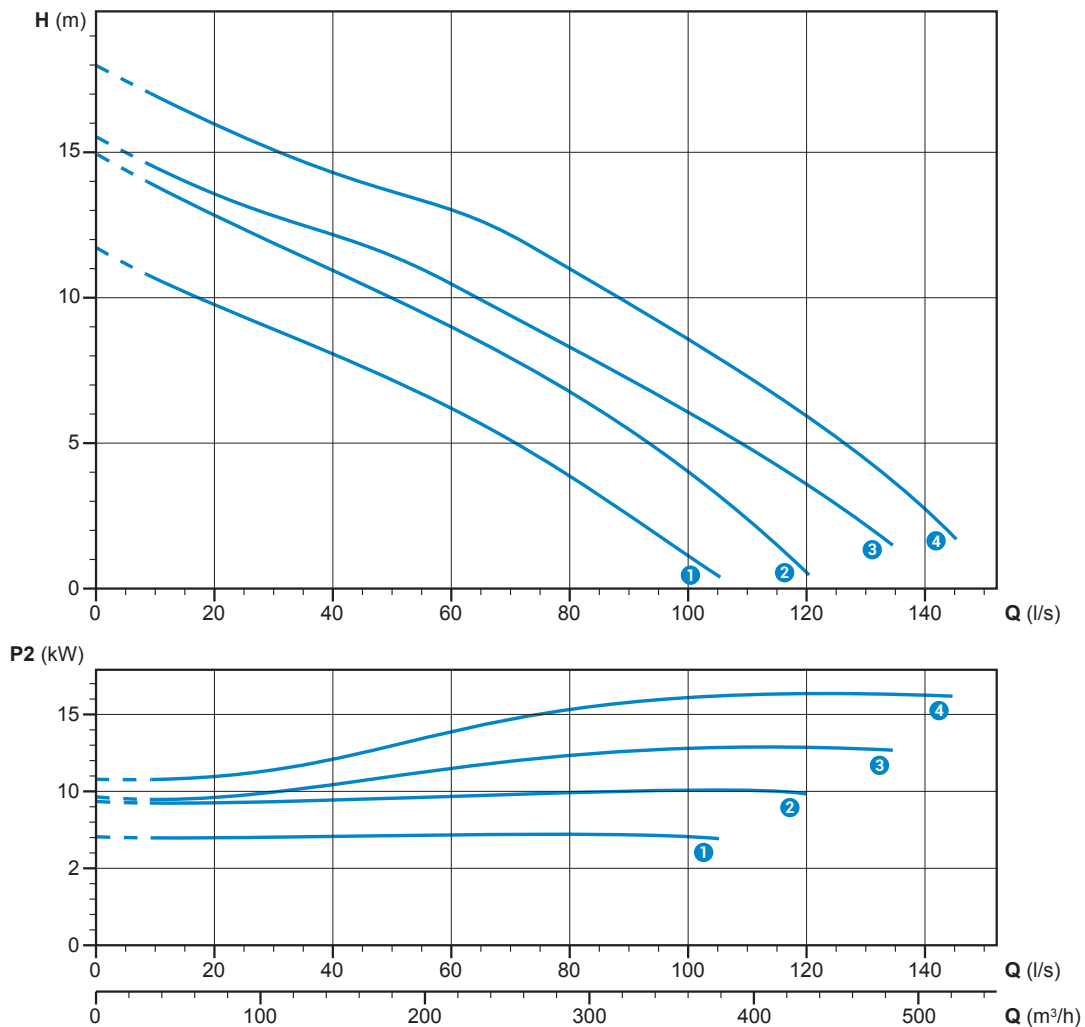

Technical data

	V	Phases	P1 (kW)	P2 (kW)	A	Rpm	Start	Cable	Ø	Free passage
① DRP 750/4/150 A0HT5	400	3	9.1	7.4	15.82	1450	Y Δ	7G1.5 + 3x0.75	DN150	95 mm
② DRP 1000/4/150 A0HT5	400	3	12.8	10.45	21.74	1450	Y Δ	7G1.5 + 3x0.75	DN150	95 mm
③ DRP 1500/4/150 A0IT5	400	3	17.5	14.7	31.18	1450	Y Δ	2x 4G6 + 2G1	DN150	110x95 mm
④ DRP 2000/4/150 A0IT5	400	3	22.5	18.8	39.60	1450	Y Δ	2x 4G6 + 2G1	DN150	115x95 mm

DRP 6/150

Performances

	l/s	0	10	20	30	40	50	60	70	80	90	100
	l/min	0	600	1200	1800	2400	3000	3600	4200	4800	5400	6000
	m ³ /h	0	36	72	108	144	180	216	252	288	324	360
①	DRP 550/6/150 A0HT5	8.0	6.8	5.9	5.4	5.0	4.1	3.3	2.5	1.7	0.7	
②	DRP 750/6/150 A0HT5	10.0	9.0	8.2	7.6	7.0	6.4	5.6	4.7	3.7	2.2	
③	DRP 1000/6/150 A0IT5	12.7	11.7	10.8	10.2	9.7	9.0	8.4	7.5	6.4	5.2	4.0

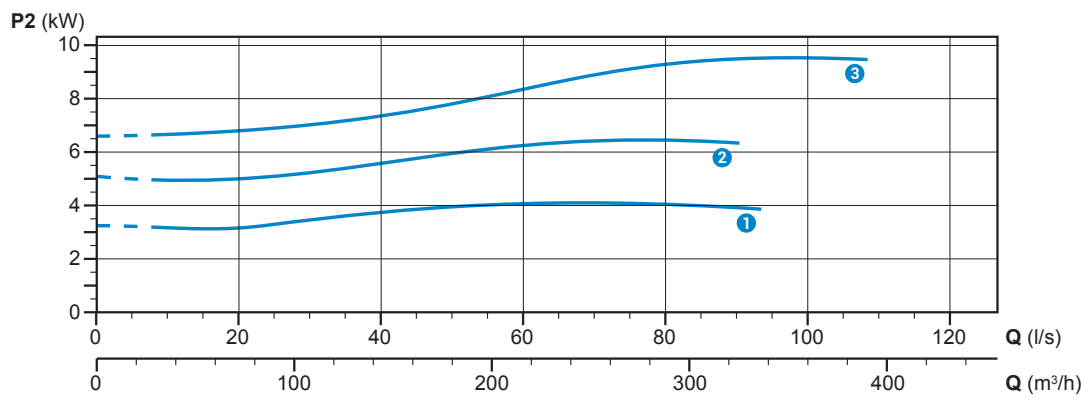
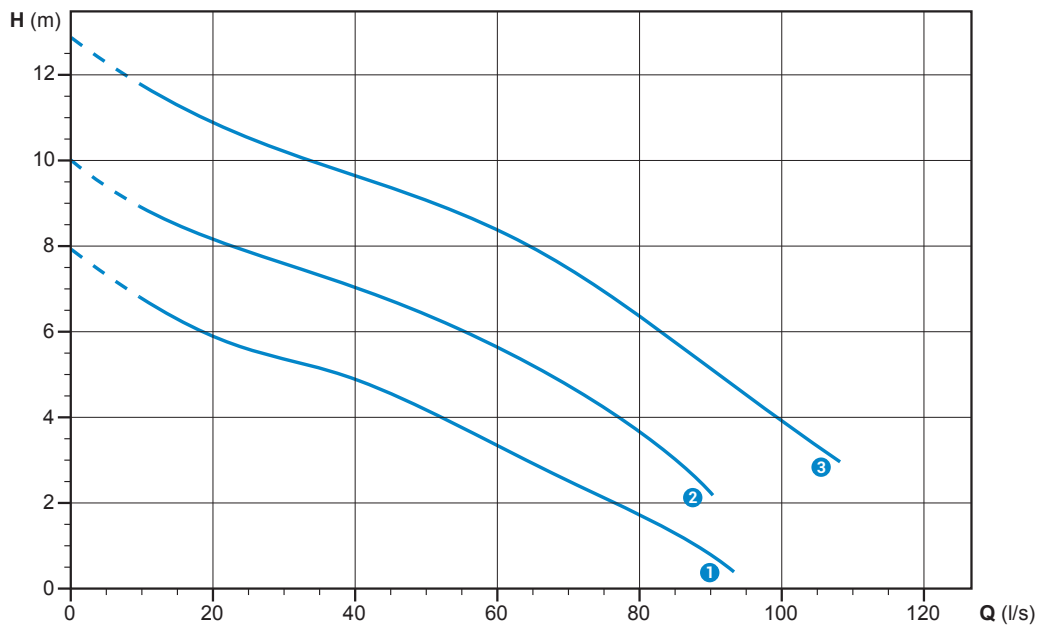

Technical data

	V	Phases	P1 (kW)	P2 (kW)	A	Rpm	Start	Cable	Ø	Free passage	
①	DRP 550/6/150 A0HT5	400	3	5.1	4.1	10.37	960	Y Δ	7G1.5 + 3x0.75	DN150	115 mm
②	DRP 750/6/150 A0HT5	400	3	8.4	6.76	15.75	960	Y Δ	2x 4G6 + 2G1	DN150	125x110 mm
③	DRP 1000/6/150 A0IT5	400	3	11.7	9.8	20.35	960	Y Δ	2x 4G6 + 2G1	DN150	125x110 mm

Characteristic curves according to UNI EN ISO 9906

Overall dimensions and weights

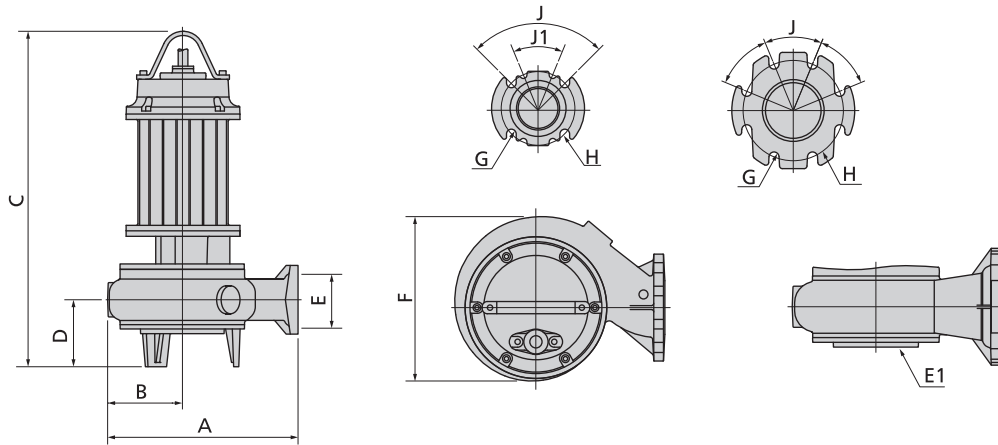

	A	B	C	D	E	E1 (*)	F	G	H	J	J1	kg
DRP 750/2/80 A0HT5	390	150	770	150	80	-	295	18	160	90°	45°	100
DRP 1000/2/80 A1HT5	390	150	770	150	80	-	295	18	160	90°	45°	105
DRP 1500/2/80 A0HT5	390	150	770	150	80	-	295	18	160	90°	45°	128
DRP 2000/2/80 A0IT5	390	150	935	150	80	DN80 PN6	310	18	160	90°	45°	158
DRP 1000/2/100 A1HT5	415	160	798	155	100	-	310	18	180	45°	-	108
DRP 1500/2/100 A0HT5	415	160	830	155	100	-	310	18	180	45°	-	130
DRP 550/4/80 A0GT5	390	150	725	150	80	DN80 PN6	290	18	160	90°	45°	82
DRP 750/4/80 A0HT5	445	175	810	155	80	DN80 PN6	340	18	160	90°	45°	125
DRP 1000/4/80 A0HT5	445	175	810	155	80	DN80 PN6	340	18	160	90°	45°	133
DRP 1500/4/80 A0IT5	455	200	950	150	80	-	435	18	160	90°	-	181
DRP 2000/4/80 A0IT5	455	200	950	150	80	-	435	18	160	90°	-	196
DRP 550/4/100 A0GT5	415	160	740	155	100	-	310	18	180	45°	-	85
DRP 750/4/100 A0HT5	430	165	820	160	100	DN100 PN6	335	18	180	45°	-	123
DRP 1000/4/100 A0HT5	430	165	820	160	100	DN100 PN6	335	18	180	45°	-	131
DRP 1500/4/100 A0IT5	430	165	970	160	100	DN100 PN6	335	18	180	45°	-	171
DRP 1500/4/125 A0IT5	580	280	1010	200	125	DN150 PN10	555	18	210	90°	-	199
DRP 2000/4/125 A0IT5	580	280	1010	200	125	DN150 PN10	555	18	210	90°	-	220
DRP 750/4/150 A0HT5	500	215	845	190	150	DN150 PN6	400	24	240	45°	-	138
DRP 1000/4/150 A0HT5	500	215	845	190	150	DN150 PN6	400	24	240	45°	-	146
DRP 1500/4/150 A0IT5	650	255	1020	205	150	DN150 PN10	505	24	240	45°	-	213
DRP 2000/4/150 A0IT5	650	255	1020	205	150	DN150 PN10	505	24	240	45°	-	228
DRP 550/6/150 A0HT5	500	215	865	190	150	DN150 PN6	400	24	240	45°	-	141
DRP 750/6/150 A0HT5	650	255	900	205	150	DN150 PN10	505	24	240	45°	-	138
DRP 1000/6/150 A0IT5	650	255	1019	205	150	DN150 PN10	505	24	240	45°	-	213

*) DN of the suction flange - PN6

Dimensions in mm

DRP

Packaging dimension



	X	Y	Z
DRP 750/2/80 A0HT5	915	515	555
DRP 1000/2/80 A1HT5	915	515	555
DRP 1500/2/80 A0HT5	915	515	555
DRP 2000/2/80 A0IT5	915	515	555
DRP 1000/2/100 A1HT5	915	515	555
DRP 1500/2/100 A0HT5	915	515	555
DRP 550/4/80 A0GT5	725	445	415
DRP 750/4/80 A0HT5	915	515	555
DRP 1000/4/80 A0HT5	915	515	555
DRP 1500/4/80 A0IT5	915	515	555
DRP 2000/4/80 A0IT5	915	515	555
DRP 550/4/100 A0GT5	725	445	415
DRP 750/4/100 A0HT5	915	515	555
DRP 1000/4/100 A0HT5	915	515	555
DRP 1500/4/100 A0IT5	915	515	555
DRP 1500/4/125 A0IT5	1165	720	685
DRP 2000/4/125 A0IT5	1165	720	685
DRP 750/4/150 A0HT5	915	515	555
DRP 1000/4/150 A0HT5	915	515	555
DRP 1500/4/150 A0IT5	1165	720	685
DRP 2000/4/150 A0IT5	1165	720	685
DRP 550/6/150 A0HT5	1165	720	685
DRP 750/6/150 A0HT5	1165	720	685
DRP 1000/6/150 A0IT5	1165	720	685

Dimensions in mm

Single-channel closed impeller

Operating ranges

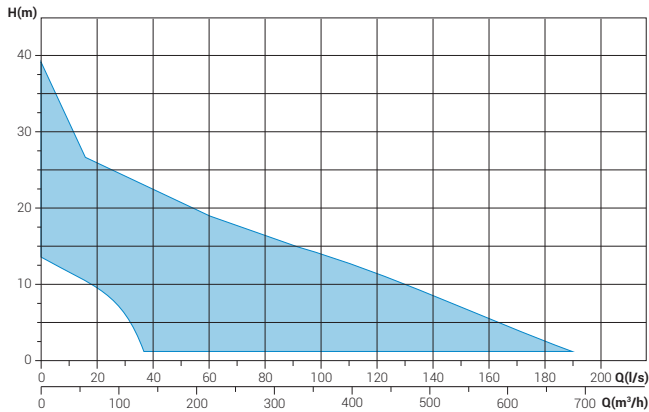

Range characteristics

Motor power	3.0 ÷ 16.4 kW
Poles	2 / 4 / 6
Insulation class	H
Degree of protection	IP68
Discharge	DN80 ÷ DN250 horizontal
Free passage	53 ÷ 130 mm
Max flow rate	182.9 l/s
Prevalenza max	39.3 m

Motor

Oil-bath motor with thermal protections.

Cable

S1RN8-F type electrical cable. 10 m standard cable length

Mechanical seals

Two mechanical seals in silicon carbide (2SiC) and one mechanical seal in alumina graphite (AL)

Applications

Designed for heavy-duty applications, they are generally used in wastewater treatment, residential and sewer plants and for the treatment of wastewater from public establishments. Suitable for pumping industrial sludges.

Installations

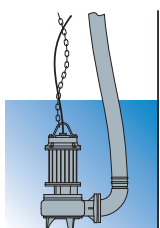

Free

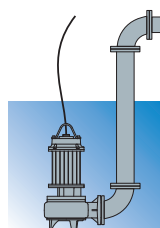

Fixed

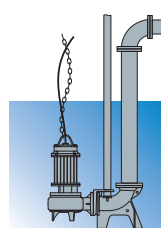

with base coupling foot

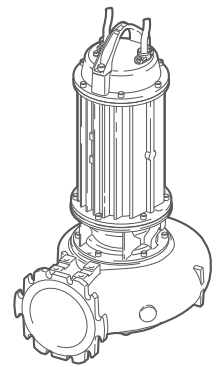
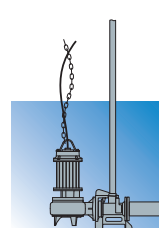

Versions

Electrical variants	T, TS
Cooling system	N
Mechanical seals	2SICAL

Operating specifications

Max operating temperature	40 °C
PH of treated fluid	6 ÷ 14
Viscosity of treated fluid	1 mm²/s
Maximum immersion depth	20 m
Density of treated fluid	1 Kg/dm³
Acoustic pressure max	<70dB
Max starts per hour	20

Construction materials

Case	Cast iron EN-GJL 250
Hydraulic parts	Cast iron EN-GJL 250
Impeller	Cast iron EN-GJL 250
Nuts and bolts	Stainless steel - Class A2-70
Standard gasket	Rubber - NBR
Shaft	Stainless steel - AISI 420
Cooling jacket (optional)	Stainless steel - AISI 304
Paint type	Ecological bicomponent epoxy (~ 150 µm)

SMP 2/80

Performances

	l/s	0	5	10	15	20	25	30	35
	l/min	0	300	600	900	1200	1500	1800	2100
	m ³ /h	0	18	36	54	72	90	108	126
① SMP 550/2/80 A0GT5		31.0	27.1	24.0	20.5	16.8	12.5	8.0	1.8
② SMP 750/2/80 A0HT5		35.0	28.0	23.5	20.5	17.5	13.8	10.0	5.0
③ SMP 1000/2/80 A0HT5		39.0	33.5	29.5	26.0	22.5	18.5	13.8	7.2

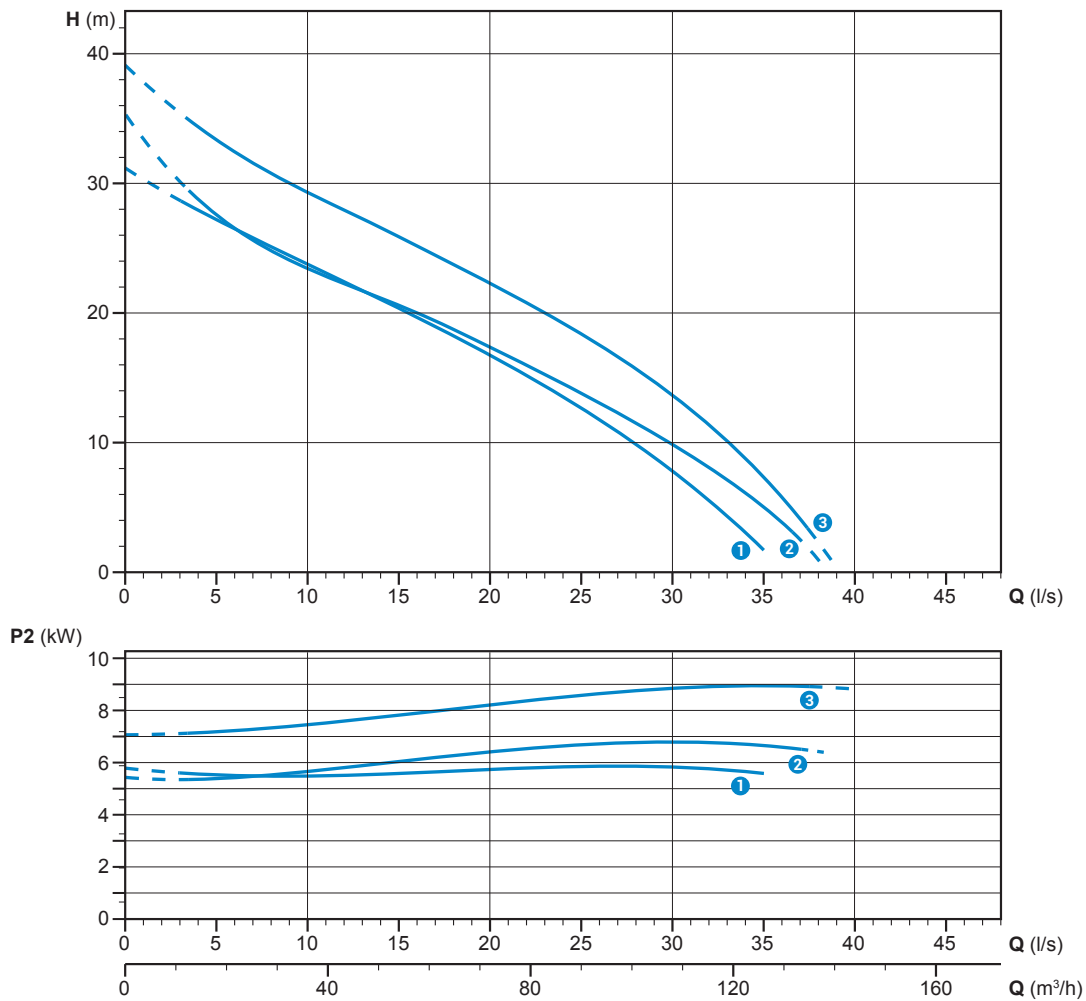

Characteristic curves according to UNI EN ISO 9906

Technical data

	V	Phases	P1 (kW)	P2 (kW)	A	Rpm	Start	Cable	Ø	Free passage
① SMP 550/2/80 A0GT5	400	3	7.35	5.8	12.06	2900	Dir	4G2.5 + 3x1	DN80	53 mm
② SMP 750/2/80 A0HT5	400	3	10.0	7.9	16.04	2900	Y Δ	7G1.5 + 3x0.75	DN80	65x55 mm
③ SMP 1000/2/80 A0HT5	400	3	13.6	10.8	21.57	2900	Y Δ	7G1.5 + 3x0.75	DN80	65x55 mm

SMP 4/100

Performances

	l/s	0	5	10	15	20	25	30	35	40	45	50	55	60	65
	l/min	0	300	600	900	1200	1500	1800	2100	2400	2700	3000	3300	3600	3900
	m ³ /h	0	18	36	54	72	90	108	126	144	162	180	198	216	234
① SMP 400/4/100 A0FT5		13.5	11.2	9.8	8.8	8.0	6.8	6.0	4.9	3.5	2.0				
② SMP 750/4/100 A0HT5		19.1	16.7	14.9	13.5	12.7	12.0	11.1	10.3	9.5	8.5	7.5	6.5	5.3	4.1
③ SMP 1000/4/100 A0HT5		22.5	19.8	18.4	17.2	16.5	15.0	14.0	13.0	12.0	10.3	9.0	7.5	5.8	

Characteristic curves according to UNI EN ISO 9906

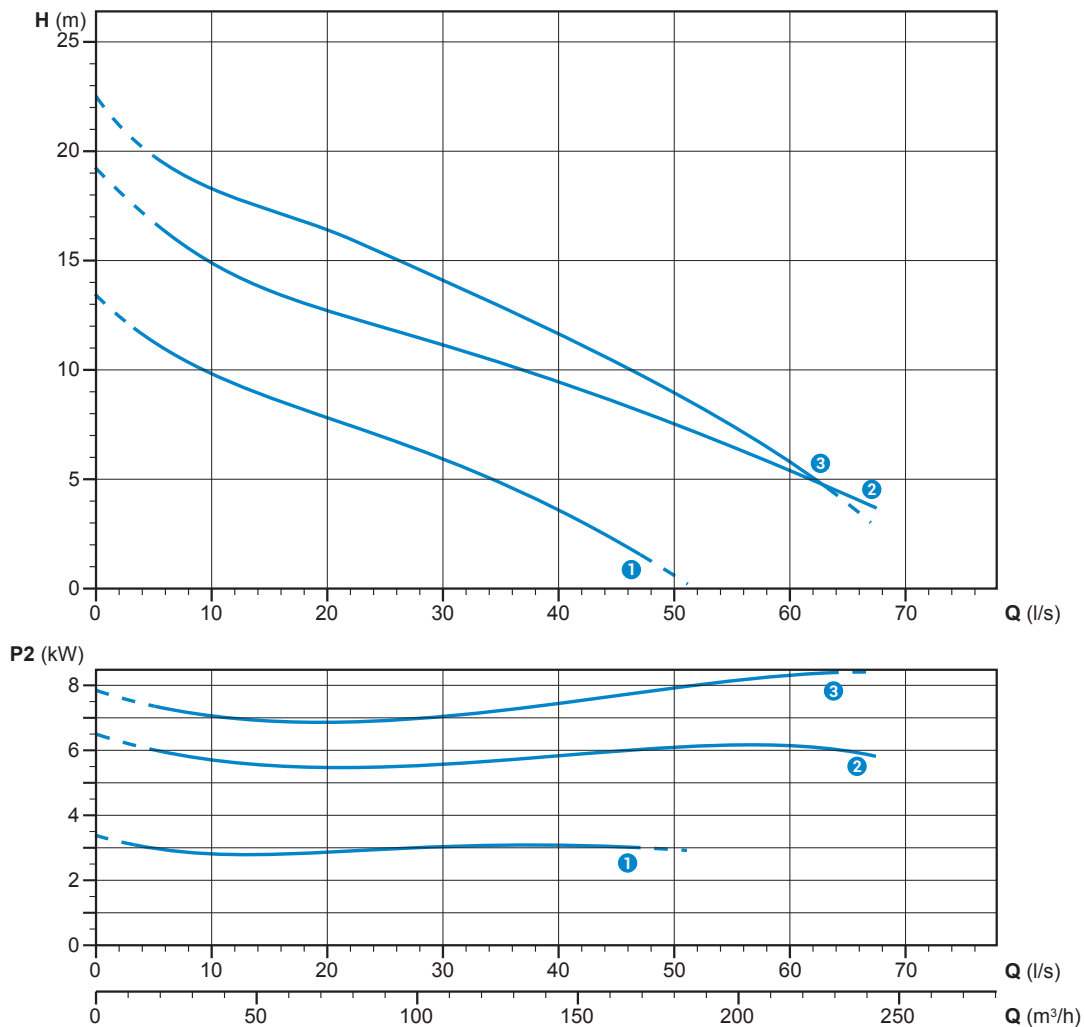

Technical data

	V	Phases	P1 (kW)	P2 (kW)	A	Rpm	Start	Cable	∅	Free passage
① SMP 400/4/100 A0FT5	400	3	4.1	3.0	7.90	1450	Dir	4G1.5 + 2G1	DN100	100x75 mm
② SMP 750/4/100 A0HT5	400	3	9.1	7.4	15.82	1450	Y Δ	7G1.5 + 3x0.75	DN100	100x80 mm
③ SMP 1000/4/100 A0HT5	400	3	12.8	10.45	21.74	1450	Y Δ	7G1.5 + 3x0.75	DN100	80 mm

SMP 4/150

Performances

	l/s	0	10	20	30	40	50	60	70
	l/min	0	600	1200	1800	2400	3000	3600	4200
	m ³ /h	0	36	72	108	144	180	216	252
① SMP 400/4/150 A0FT5		13.2	9.5	8.0	6.5	4.2	1.8		
② SMP 750/4/150 A0HT5		18.5	14.7	12.5	11.0	9.5	7.4	5.0	
③ SMP 1000/4/150 A0HT5		22.4	18.2	16.4	14.7	12.5	10.1	7.6	4.0

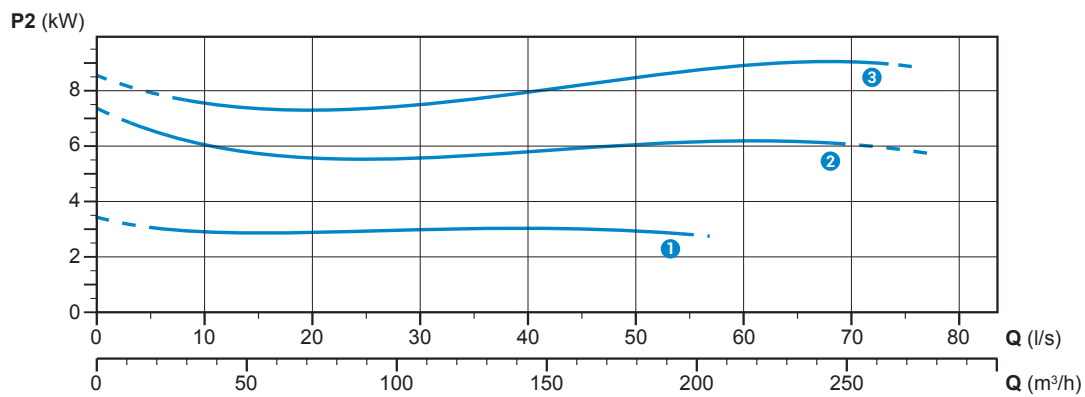
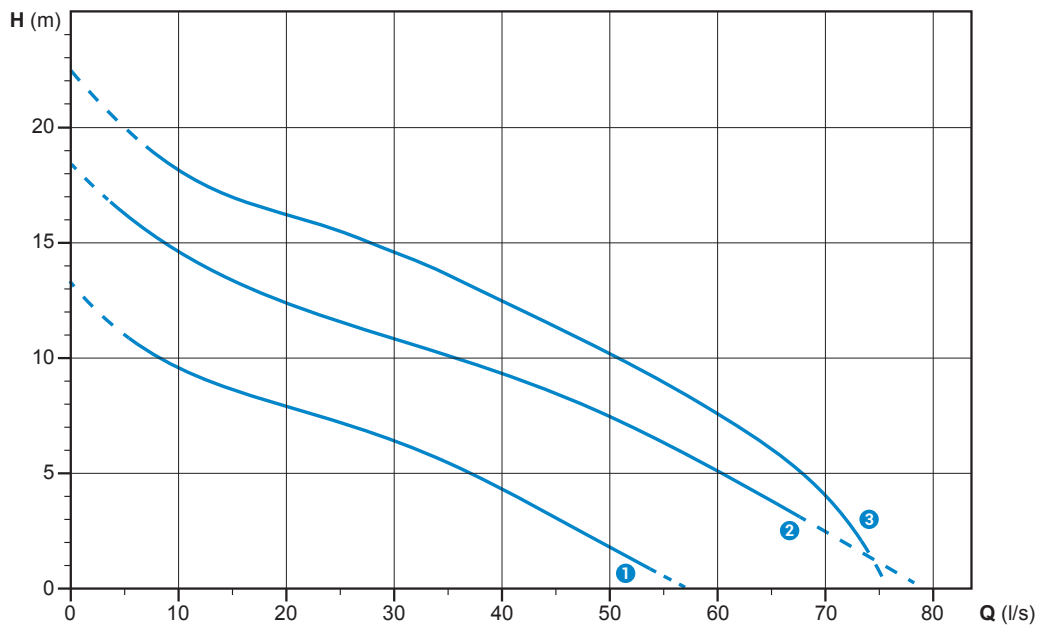

Technical data

	V	Phases	P1 (kW)	P2 (kW)	A	Rpm	Start	Cable	Ø	Free passage
① SMP 400/4/150 A0FT5	400	3	4.1	3.0	7.90	1450	Dir	4G1.5 + 2G1	DN150	100x75 mm
② SMP 750/4/150 A0HT5	400	3	9.1	7.4	15.82	1450	Y Δ	7G1.5 + 3x0.75	DN150	100x80 mm
③ SMP 1000/4/150 A0HT5	400	3	12.8	10.45	21.74	1450	Y Δ	7G1.5 + 3x0.75	DN150	80 mm

Characteristic curves according to UNI EN ISO 9906

SMP 4/150

Performances

	l/s	0	10	20	30	40	50	60	70	80	90	100	110	120	130	140
	l/min	0	600	1200	1800	2400	3000	3600	4200	4800	5400	6000	6600	7200	7800	8400
	m ³ /h	0	36	72	108	144	180	216	252	288	324	360	396	432	468	504
① SMP 1500/4/150 A0IT5		24.7	20.5	18.0	16.4	15.2	14.0	12.8	11.0	9.1	7.6	6.0	3.9	2.0		
② SMP 2000/4/150 A0IT5		29.2	26.0	23.2	21.0	19.1	17.8	16.5	15.0	13.5	11.8	9.9	8.0	6.4	4.0	2.0

Characteristic curves according to UNI EN ISO 9906

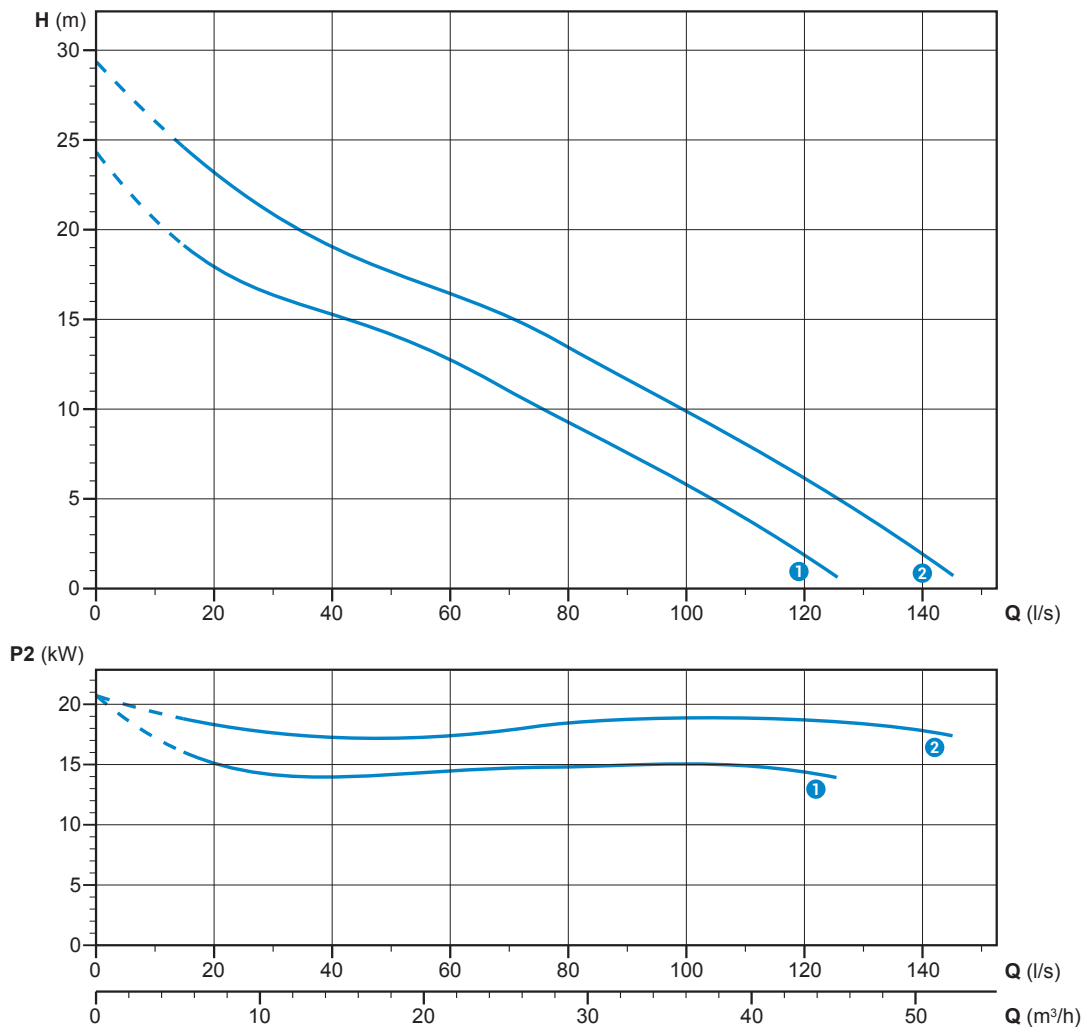

Technical data

	V	Phases	P1 (kW)	P2 (kW)	A	Rpm	Start	Cable	Ø	Free passage
① SMP 1500/4/150 A0IT5	400	3	17.5	14.7	31.18	1450	Y Δ	2x 4G6 + 2G1	DN150	110x95 mm
② SMP 2000/4/150 A0IT5	400	3	22.5	18.8	39.60	1450	Y Δ	2x 4G6 + 2G1	DN150	130x100 mm

SMP 4-6/200

Performances

	l/s	0	20	40	60	80	100	120	140
	l/min	0	1200	2400	3600	4800	6000	7200	8400
	m ³ /h	0	72	144	216	288	360	432	504
① SMP 2000/4/200 A0IT5		29.0	22.5	19.0	16.2	13.6	10.8	7.8	4.0
② SMP 750/6/200 A0HT5		15.0	11.1	9.2	7.5	5.5	3.0	0.3	

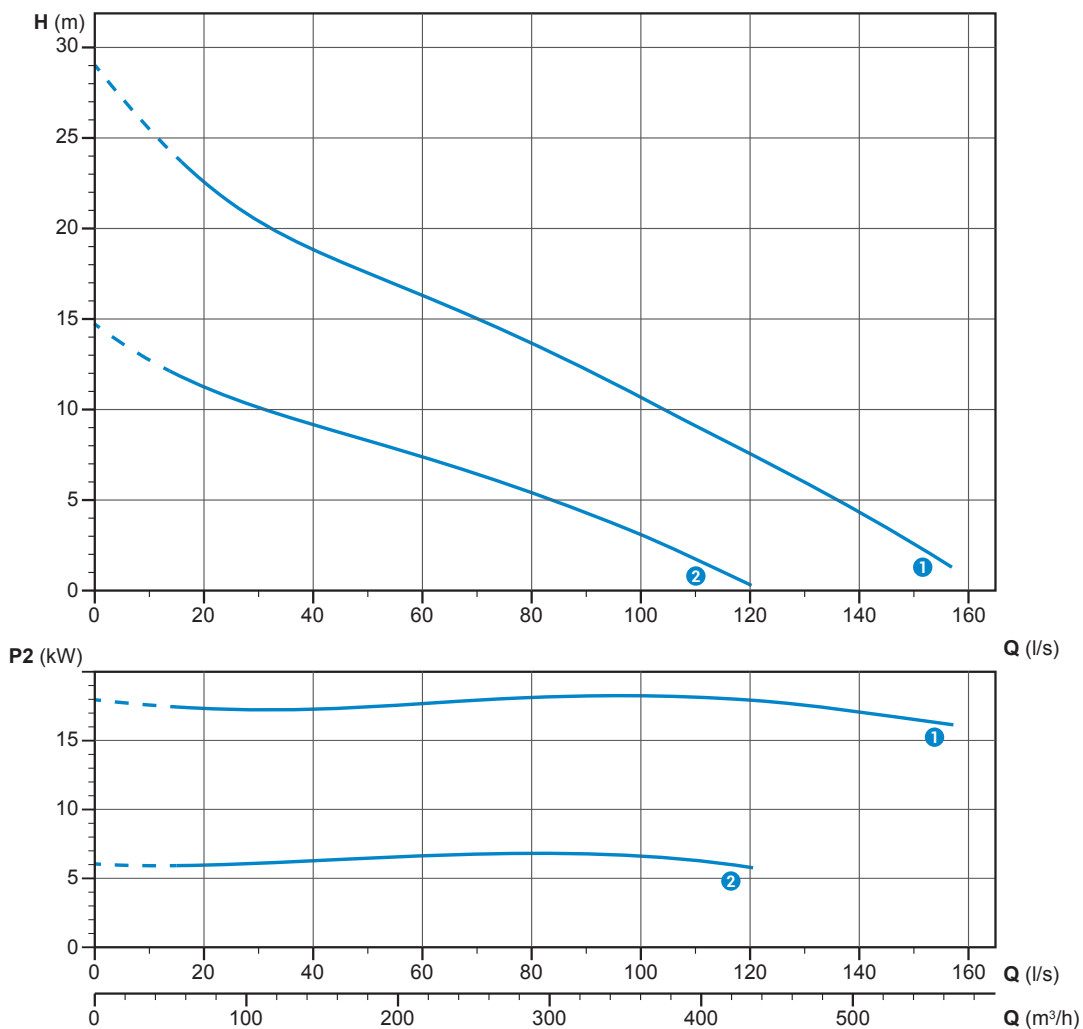

Characteristic curves according to UNI EN ISO 9906

Technical data

	V	Phases	P1 (kW)	P2 (kW)	A	Rpm	Start	Cable	Ø	Free passage
① SMP 2000/4/200 A0IT5	400	3	22.5	18.8	39.60	1450	Y Δ	2x 4G6 + 2G1	DN200	130x100 mm
② SMP 750/6/200 A0HT5	400	3	8.4	6.76	15.75	960	Y Δ	7G1.5 + 3x0.75	DN200	130x100 mm

SMP 4-6/250

Performances

	0	20	40	60	80	100	120	140	160
I/s	0	20	40	60	80	100	120	140	160
l/min	0	1200	2400	3600	4800	6000	7200	8400	9600
m ³ /h	0	72	144	216	288	360	432	504	576
① SMP 2000/4/250 A0IT5	27.3	21.5	18.0	15.7	13.7	11.3	8.4	5.0	2.0
② SMP 750/6/250 A0HT5	14.1	10.6	9.0	7.5	5.8	3.6	1.0		

Characteristic curves according to UNI EN ISO 9906

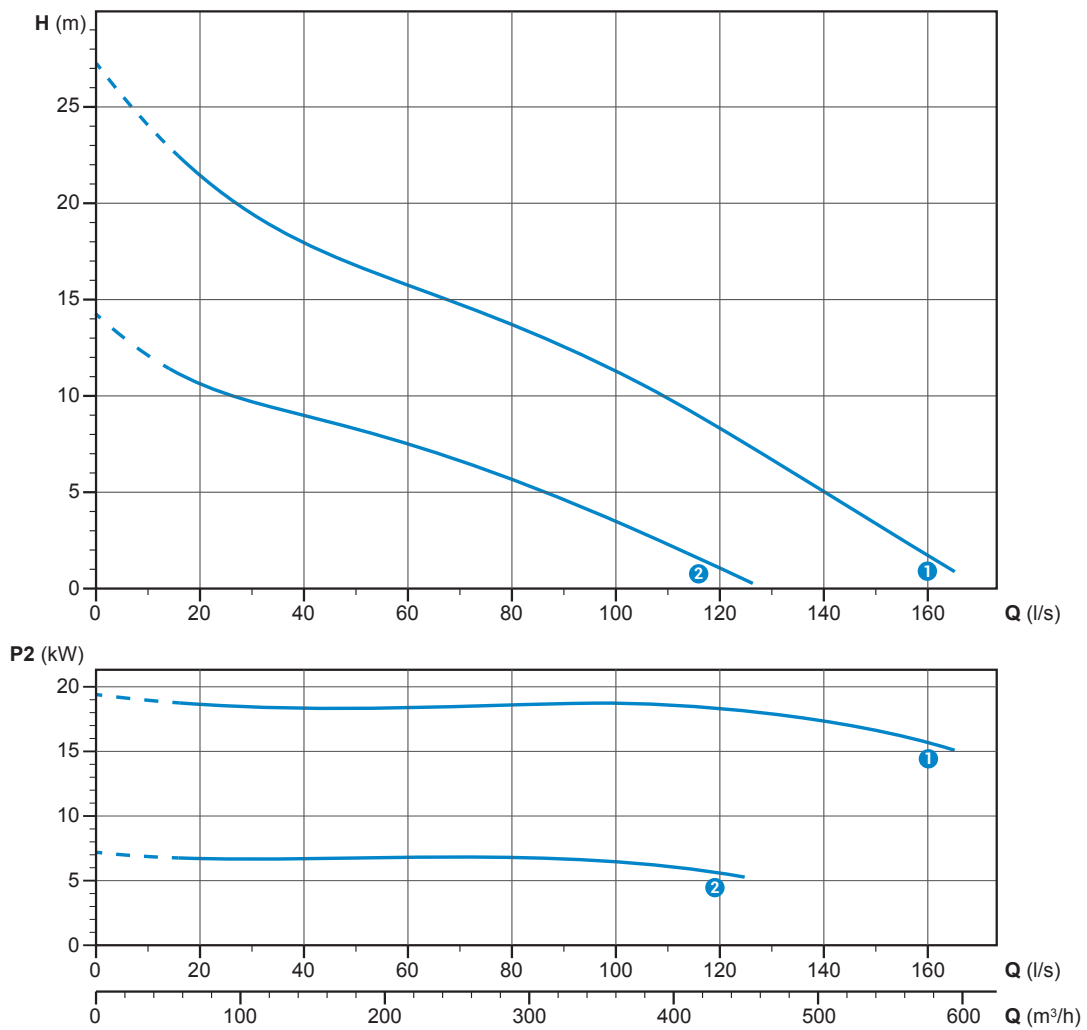

Technical data

	V	Phases	P1 (kW)	P2 (kW)	A	Rpm	Start	Cable	∅	Free passage
① SMP 2000/4/250 A0IT5	400	3	22.5	18.8	39.60	1450	Y Δ	2x 4G6 + 2G1	DN200	130x100 mm
② SMP 750/6/250 A0HT5	400	3	8.4	6.76	15.75	960	Y Δ	7G1.5 + 3x0.75	DN200	130x100 mm

SMP

Overall dimensions and weights

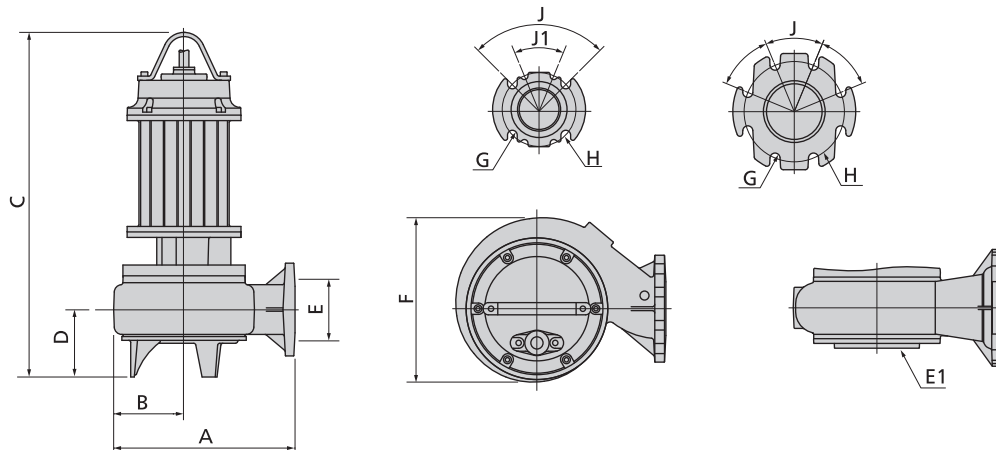

	A	B	C	D	E	E1 (*)	F	G	H	J	J1	kg
SMP 550/2/80 A0GT5	390	150	735	150	80	-	290	18	160	90°	45°	73
SMP 750/2/80 A0HT5	390	150	795	150	80	-	295	18	160	90°	45°	76
SMP 1000/2/80 A0HT5	390	150	795	150	80	-	295	18	160	90°	45°	110
SMP 400/4/100 A0FT5	505	200	700	130	100	-	395	18	180	45°	-	81
SMP 750/4/100 A0HT5	505	200	780	120	100	DN150 PN6	395	18	180	45°	-	132
SMP 1000/4/100 A0HT5	505	200	760	100	100	DN150 PN6	395	18	180	45°	-	141
SMP 400/4/150 A0FT5	507	200	700	130	150	-	395	24	240	45°	-	88
SMP 750/4/150 A0HT5	505	200	780	120	150	DN150 PN6	395	24	240	45°	-	140
SMP 1000/4/150 A0HT5	505	200	760	100	150	DN150 PN6	395	24	240	45°	-	150
SMP 1500/4/150 A0IT5	650	255	955	140	150	DN200 PN6	505	24	240	45°	-	206
SMP 2000/4/150 A0IT5	650	255	955	140	150	DN200 PN6	505	24	240	45°	-	252
SMP 2000/4/200 A0IT5	695	275	970	145	200	DN200 PN6	540	24	295	45°	-	221
SMP 2000/4/250 A0IT5	785	310	970	145	250	DN200 PN6	610	24	350	30°	-	229
SMP 750/6/200 A0HT5	695	275	850	145	200	DN200 PN6	540	24	295	45°	-	190
SMP 750/6/250 A0HT5	785	310	850	145	250	DN200 PN6	610	24	350	30°	-	198

(*) DN of the suction flange

Dimensions in mm

Packaging dimension



	X	Y	Z
SMP 550/2/80 A0GT5	915	515	555
SMP 750/2/80 A0HT5	915	515	555
SMP 1000/2/80 A0HT5	915	515	555
SMP 400/4/100 A0FT5	725	445	415
SMP 750/4/100 A0HT5	915	515	555
SMP 1000/4/100 A0HT5	915	515	555
SMP 400/4/150 A0FT5	915	515	555
SMP 750/4/150 A0HT5	915	515	555
SMP 1000/4/150 A0HT5	915	515	555



	X	Y	Z
SMP 1500/4/150 A0IT5	915	515	555
SMP 2000/4/150 A0IT5	1165	720	685
SMP 2000/4/200 A0IT5	1165	720	685
SMP 2000/4/250 A0IT5	1165	720	685
SMP 750/6/200 A0HT5	1165	720	685
SMP 750/6/250 A0HT5	1165	720	685

Dimensions in mm

Dual-channel closed impeller

Operating ranges

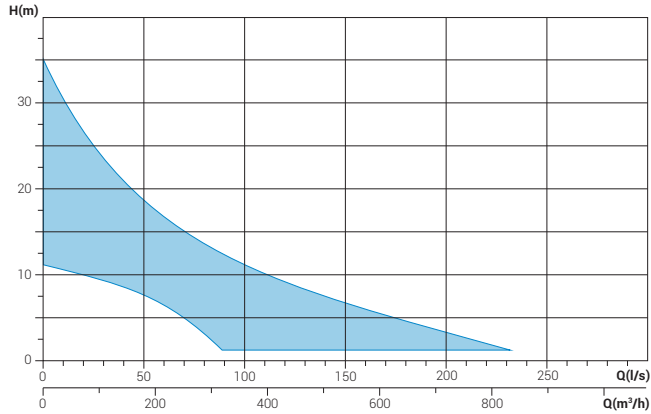

Range characteristics

Motor power	6.5 ÷ 12.3 kW
Poles	2 / 4 / 6
Insulation class	H
Degree of protection	IP68
Discharge	DN80 ÷ DN250 horizontal
Free passage	36 ÷ 140 mm
Max flow rate	232.6 l/s
Prevalenza max	34.2 m

Motor

Oil-bath motor with thermal protections.

Cable

S1RN8-F type electrical cable. 10 m standard cable length

Mechanical seals

Two mechanical seals in silicon carbide (2SiC) and one mechanical seal in alumina graphite (AL)

Applications

Suitable for heavy-duty industrial applications, they are generally used in civil and industrial wastewater treatment plants, for lifting sewage, for pumping industrial sludges and rainwater containing solids, and for recycling raw or activated sludges and biological liquids.

Installations

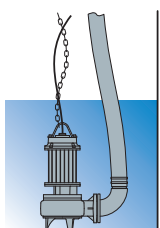

Free

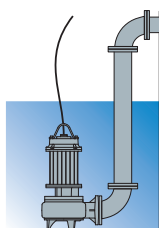

Fixed

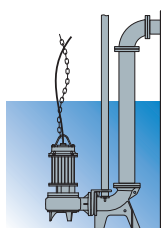

with base coupling foot

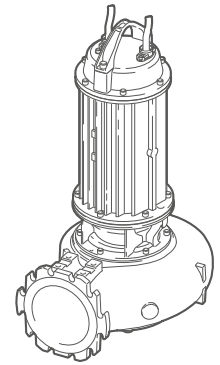
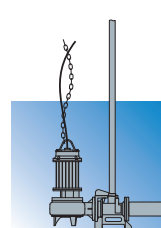

Versions

Electrical variants	T, TS
Cooling system	N
Mechanical seals	2SICAL

Operating specifications

Max operating temperature	40 °C
PH of treated fluid	6 ÷ 14
Viscosity of treated fluid	1 mm²/s
Maximum immersion depth	20 m
Density of treated fluid	1 Kg/dm³
Acoustic pressure max	<70dB
Max starts per hour	20

Construction materials

Case	Cast iron EN-GJL 250
Hydraulic parts	Cast iron EN-GJL 250
Impeller	Cast iron EN-GJL 250
Nuts and bolts	Stainless steel - Class A2-70
Standard gasket	Rubber - NBR
Shaft	Stainless steel - AISI 420
Cooling jacket (optional)	Stainless steel - AISI 304
Paint type	Ecological bicomponent epoxy (~ 150 µm)

SBP 2/80

Performances

	l/s	0	5	10	15	20	25
	l/min	0	300	600	900	1200	1500
	m ³ /h	0	18	36	54	72	90
① SBP 750/2/80 A0HT5		34.0	29.4	26.4	24.2	22.0	18.0

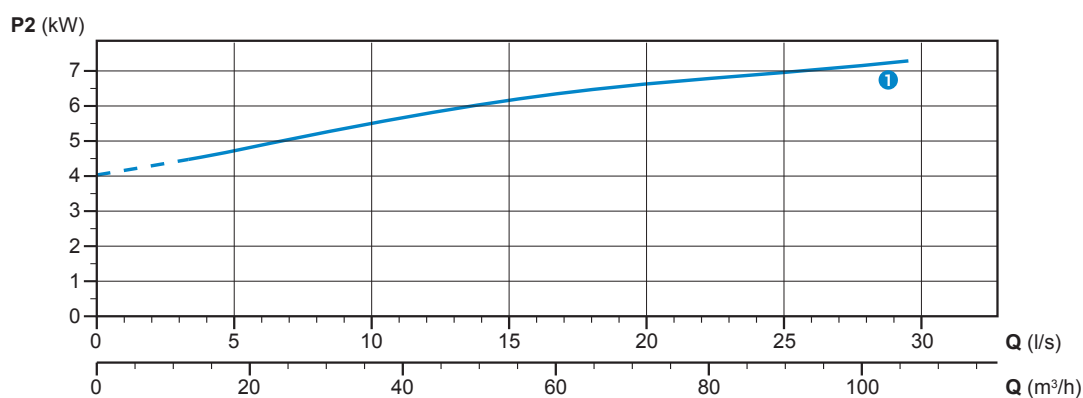
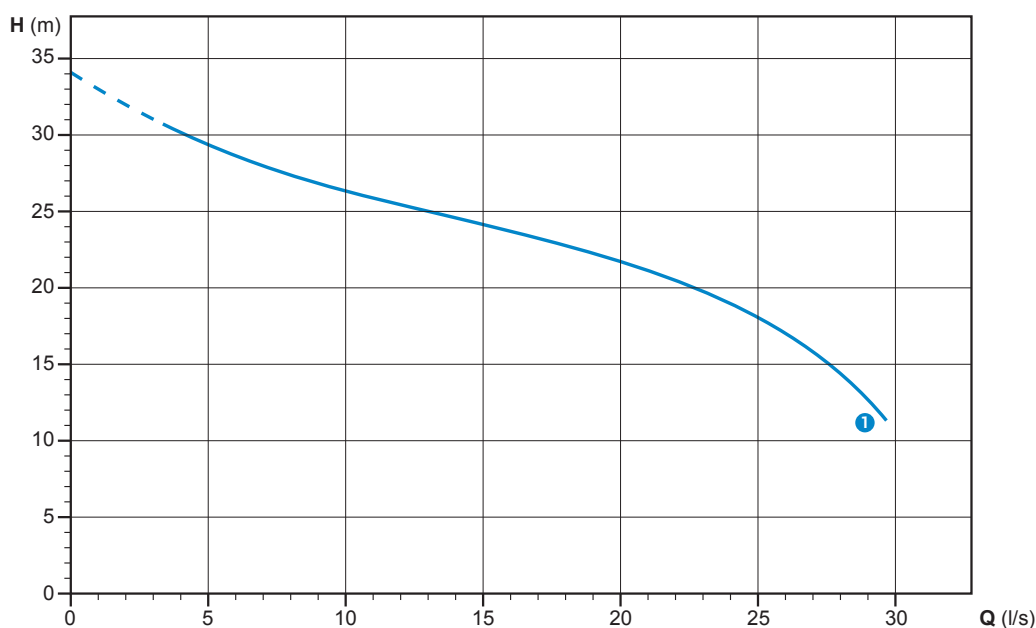

Technical data

	V	Phases	P1 (kW)	P2 (kW)	A	Rpm	Start	Cable	Ø	Free passage
① SBP 750/2/80 A0HT5	400	3	10.0	7.9	16.04	2900	Y Δ	7G1.5 + 3x0.75	DN80	36 mm

Characteristic curves according to UNI EN ISO 9906

SBP 4/150

Performances

	0	10	20	30	40	50	60	70	80
1 SBP 750/4/150 A0HT5	17.6	15.5	13.9	12.0	10.5	8.5	6.5	4.2	
2 SBP 1000/4/150 A0HT5	21.5	19.1	17.2	15.1	13.4	11.6	9.4	6.6	3.2

Characteristic curves according to UNI EN ISO 9906

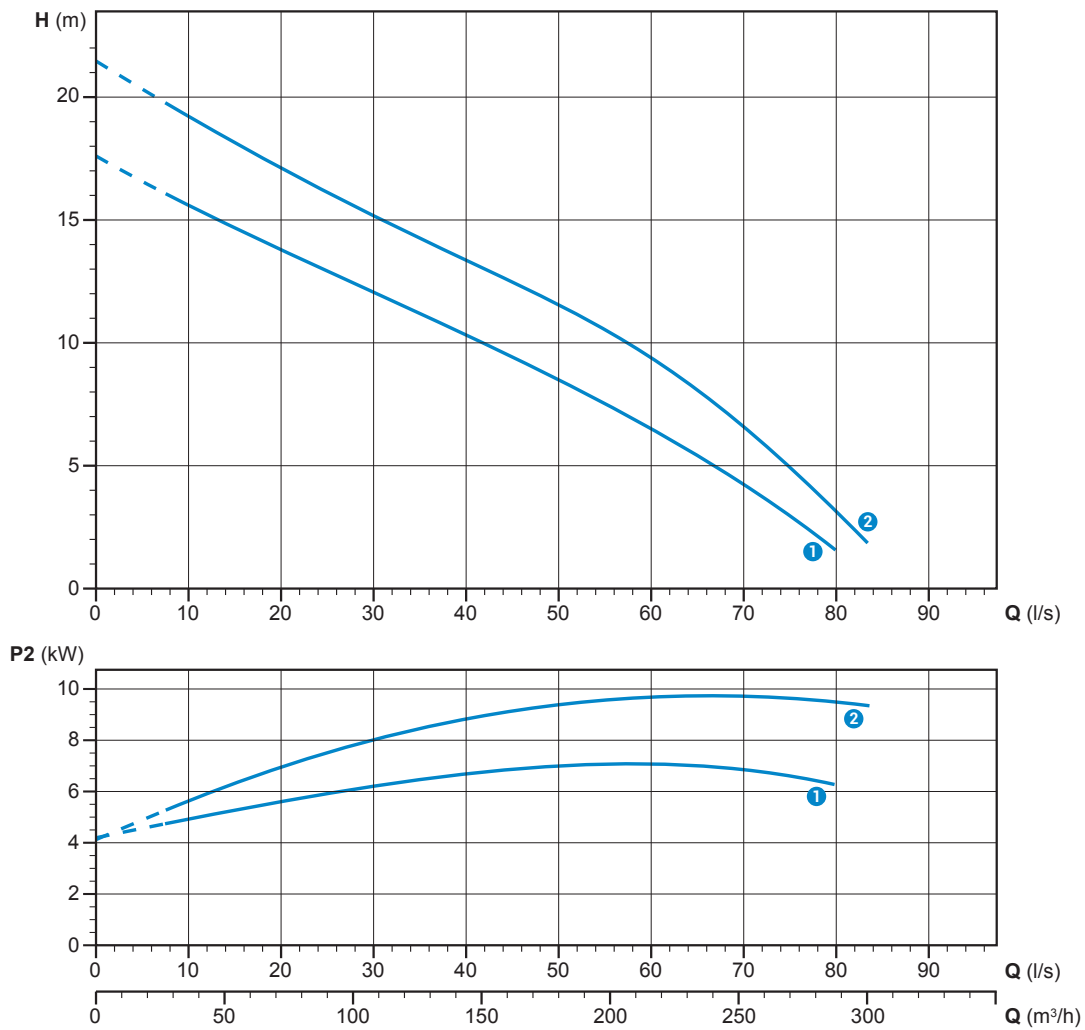

Technical data

	V	Phases	P1 (kW)	P2 (kW)	A	Rpm	Start	Cable	Ø	Free passage
1 SBP 750/4/150 A0HT5	400	3	9.1	7.4	15.82	1450	Y Δ	7G1.5 + 3x0.75	DN80	70 mm
2 SBP 1000/4/150 A0HT5	400	3	12.8	10.45	21.74	1450	Y Δ	7G1.5 + 3x0.75	DN80	70 mm

SBP 6/200

Performances

	l/s	0	20	40	60	80	100	120	140	160	180
	l/min	0	1200	2400	3600	4800	6000	7200	8400	9600	10800
	m ³ /h	0	72	144	216	288	360	432	504	576	648
① SBP 1000/6/200 A0IT5		10.5	9.5	8.4	7.2	5.8	4.5	3.0	1.4		
② SBP 1500/6/200 A1IT5		14.8	12.8	11.6	10.6	9.8	8.7	7.5	6.0	4.5	2.8

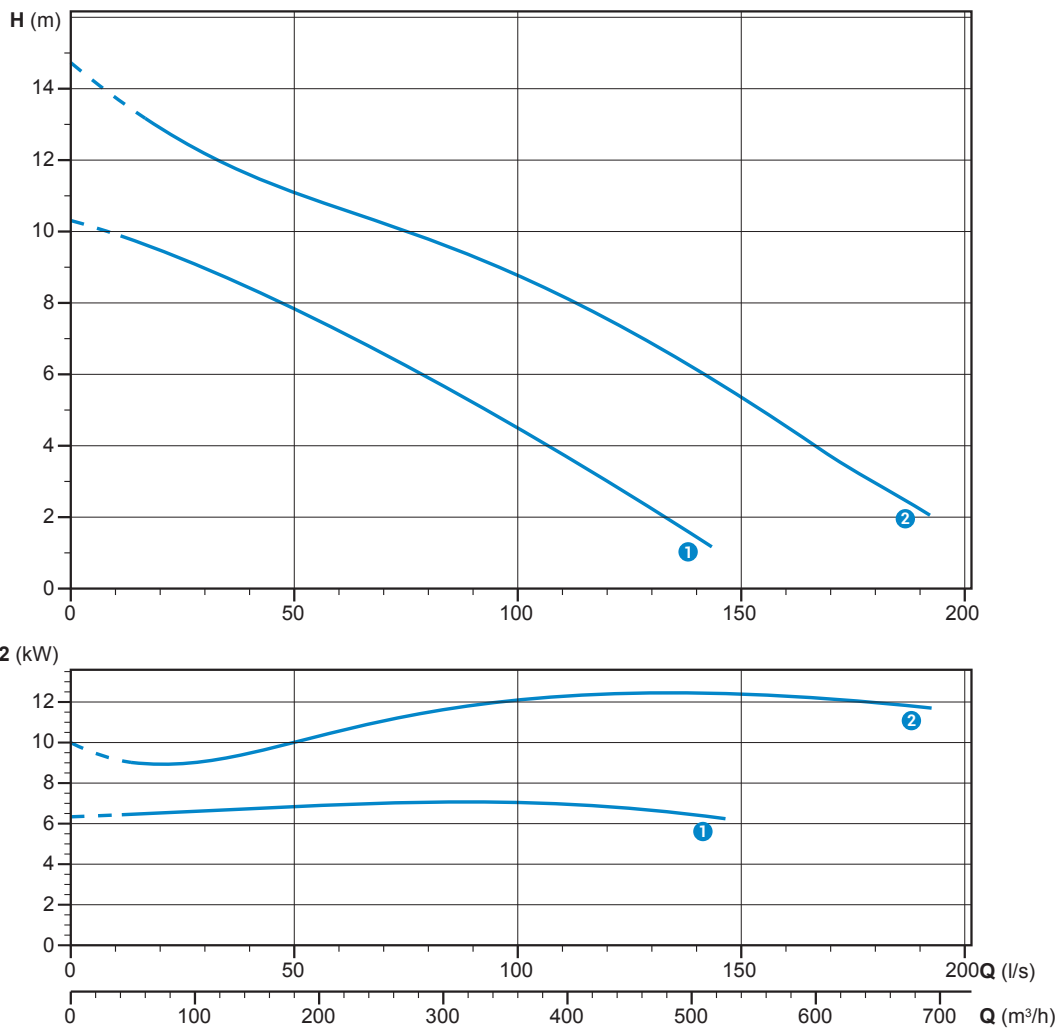

Characteristic curves according to UNI EN ISO 9906

Technical data

	V	Phases	P1 (kW)	P2 (kW)	A	Rpm	Start	Cable	Ø	Free passage
① SBP 1000/6/200 A0IT5	400	3	11.7	9.8	20.35	960	Y Δ	2x 4G6 + 2G1	DN200	100 mm
② SBP 1500/6/200 A1IT5	400	3	14.8	12.3	28.11	960	Y Δ	2x 4G6 + 2G1	DN200	140x105 mm

SBP 6/250

Performances

	l/s	0	20	40	60	80	100	120	140	160	180	200	220
	l/min	0	1200	2400	3600	4800	6000	7200	8400	9600	10800	12000	13200
	m ³ /h	0	72	144	216	288	360	432	504	576	648	720	792
① SBP 1000/6/250 C0IT5		10.7	9.2	8.2	7.4	6.5	5.4	4.1	2.6	1.0			
② SBP 1500/6/250 A1IT5		14.5	12.3	11.2	10.5	9.7	9.0	7.8	6.7	5.4	4.2	3.0	1.8

Characteristic curves according to UNI EN ISO 9906

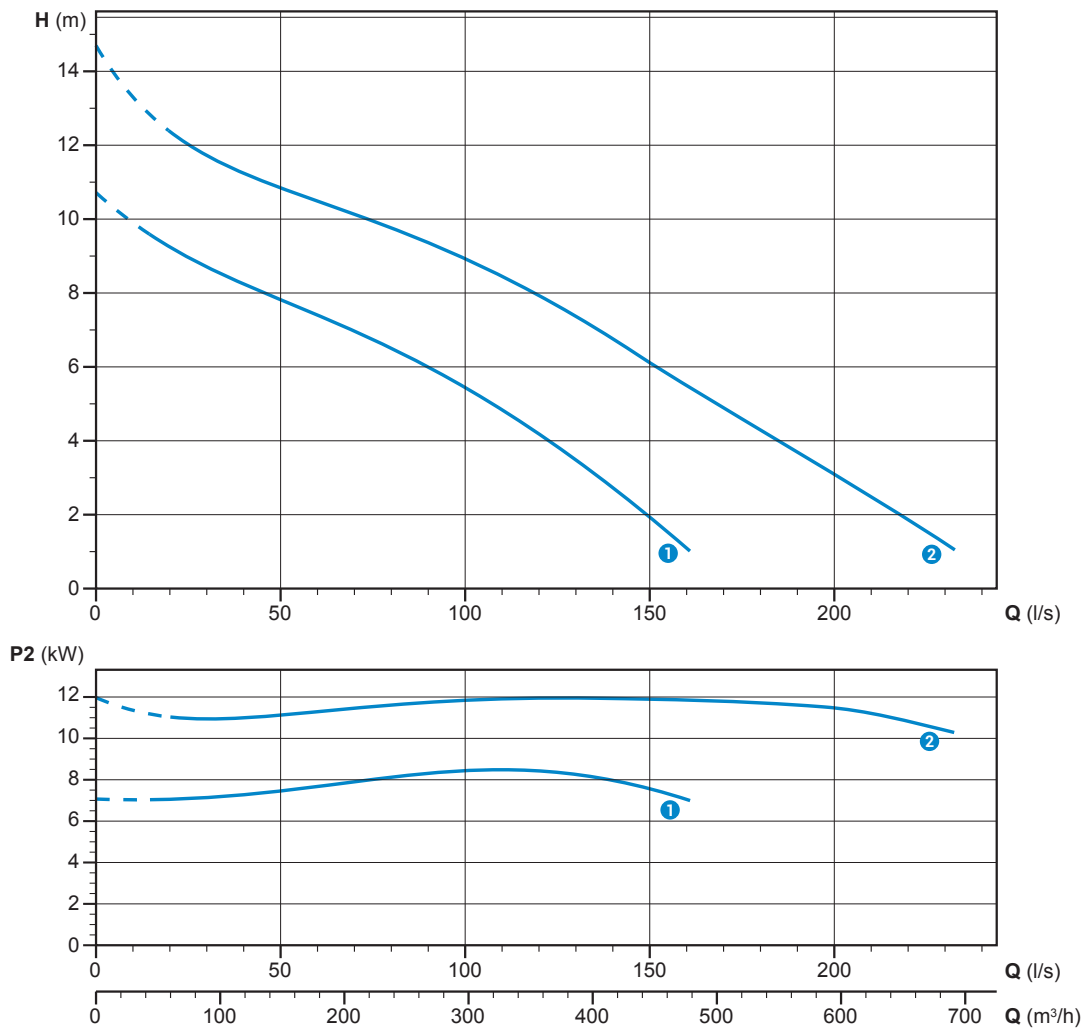

Technical data

	V	Phases	P1 (kW)	P2 (kW)	A	Rpm	Start	Cable	Ø	Free passage
① SBP 1000/6/250 C0IT5	400	3	11.7	9.8	20.35	960	Y Δ	2x 4G6 + 2G1	DN250	100 mm
② SBP 1500/6/250 A1IT5	400	3	14.8	12.3	28.11	960	Y Δ	2x 4G6 + 2G1	DN250	140x105 mm

SBP

Overall dimensions and weights

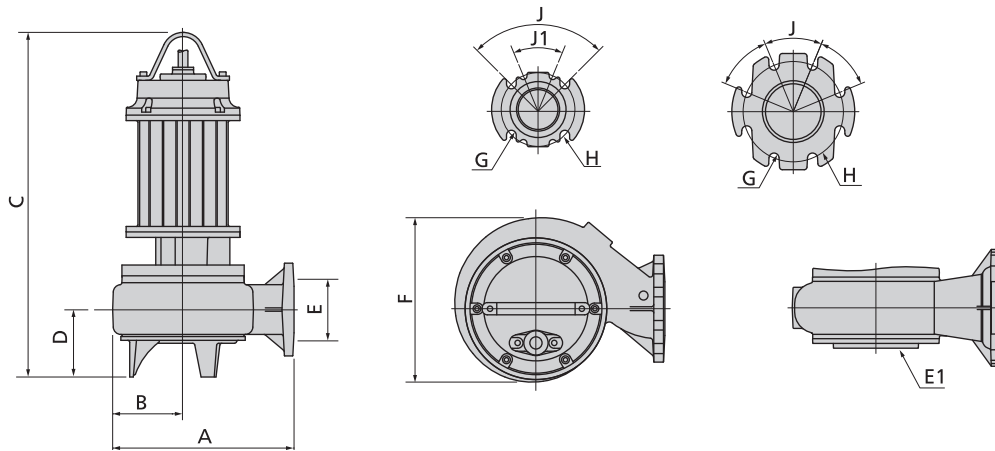

	A	B	C	D	E	E1	F	G	H	J	J1	kg
SBP 750/2/80 A0HT5	345	135	725	110	80	DN65 PN6(*)	275	18	160	90°	45°	103
SBP 750/4/150 A0HT5	585	225	855	200	150	DN125 PN6(*)	440	24	240	45°	-	135
SBP 1000/4/150 A0HT5	585	225	855	200	150	DN125 PN6(*)	440	24	240	45°	-	151
SBP 1000/6/200 A0IT5	695	275	970	145	200	DN250 PN6	540	24	295	45°	-	215
SBP 1500/6/200 A1IT5	695	275	975	155	200	DN200 PN6	540	24	295	45°	-	245
SBP 1500/6/250 A1IT5	785	310	975	155	250	DN200 PN6	610	24	350	30°	-	255

(*) Suction flange available upon request

Dimensions in mm

Packaging dimension



	X	Y	Z
SBP 750/2/80 A0HT5	915	515	555
SBP 750/4/150 A0HT5	915	515	555
SBP 1000/4/150 A0HT5	915	515	555
SBP 1000/6/200 A0IT5	1000	750	1200
SBP 1500/6/200 A1IT5	1000	750	1200
SBP 1500/6/250 A1IT5	1000	750	1200

Dimensions in mm

Impeller with grinder system

Operating ranges

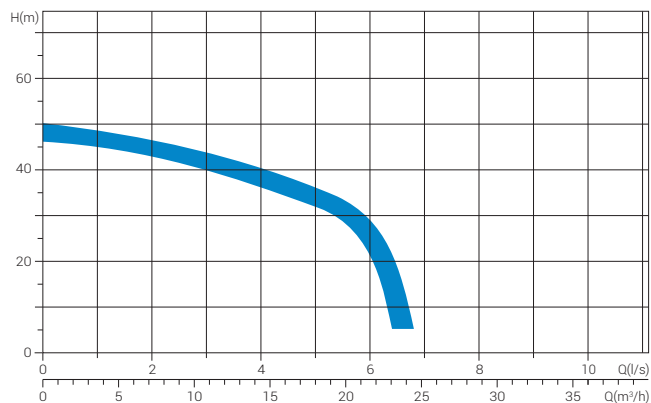

Range characteristics

Motor power	7.2 kW
Poles	2
Insulation class	H
Degree of protection	IP68
Discharge	GAS 2" DN32 horizontal
Free passage	-
Max flow rate	6.7 l/s
Prevalenza max	53.9 m

Motor

Oil-bath motor with thermal protections.

Cable

S1RN8-F type electrical cable. 10 m standard cable length

Mechanical seals

Two mechanical seals in silicon carbide (2SiC) and one mechanical seal in alumina graphite (AL)

Applications

Designed for professional and industrial use, it is suitable for the treatment of liquids containing suspended solids or fibres, and low or medium density activated sludges.

Installations

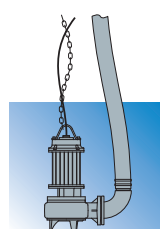

Free

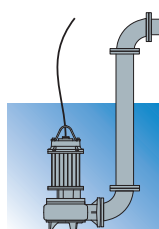

Fixed

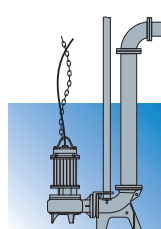

with base coupling foot

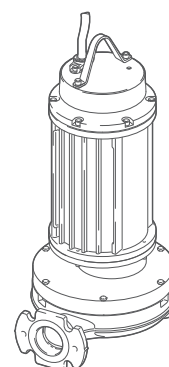
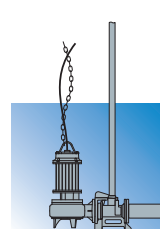

Versions

Electrical variants	T, TS
Cooling system	N
Mechanical seals	2SICAL

Operating specifications

Max operating temperature	40 °C
PH of treated fluid	6 ÷ 14
Viscosity of treated fluid	1 mm²/s
Maximum immersion depth	20 m
Density of treated fluid	1 Kg/dm³
Acoustic pressure max	<70dB
Max starts per hour	20

Construction materials

Case	Cast iron EN-GJL 250
Hydraulic parts	Cast iron EN-GJL 250
Impeller	Cast iron EN-GJL 250
Nuts and bolts	Stainless steel - Class A2-70
Standard gasket	Rubber - NBR
Shaft	Stainless steel - AISI 420
Cutter	Chromium steel
Cooling jacket (optional)	Stainless steel - AISI 304
Paint type	Ecological bicomponent epoxy (~ 150 µm)

GRP 2/G50H

Performances

	l/s	0	1	2	3	4	5	6
	l/min	0	60	120	180	240	300	360
	m ³ /h	0	3.6	7.2	10.8	14.4	18	21.6
① GRP 750/2/G50H A0HT5		53.5	52.0	49.5	47.5	44.0	40.8	36.0

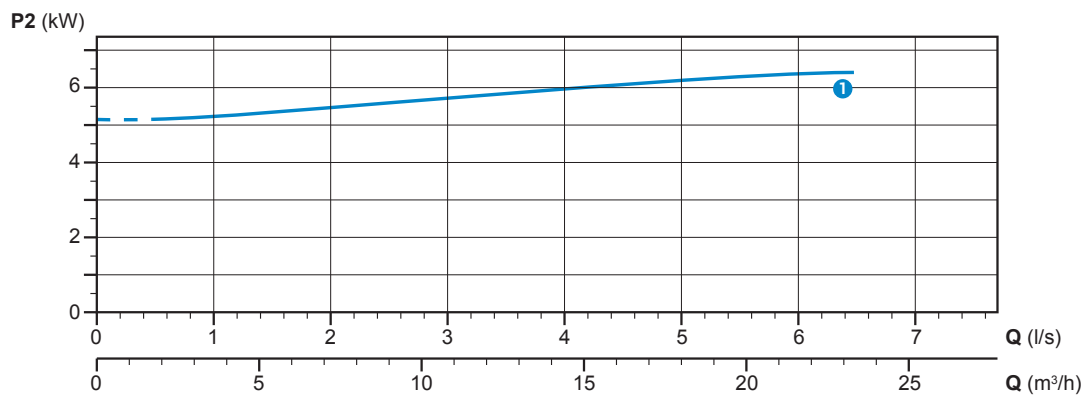
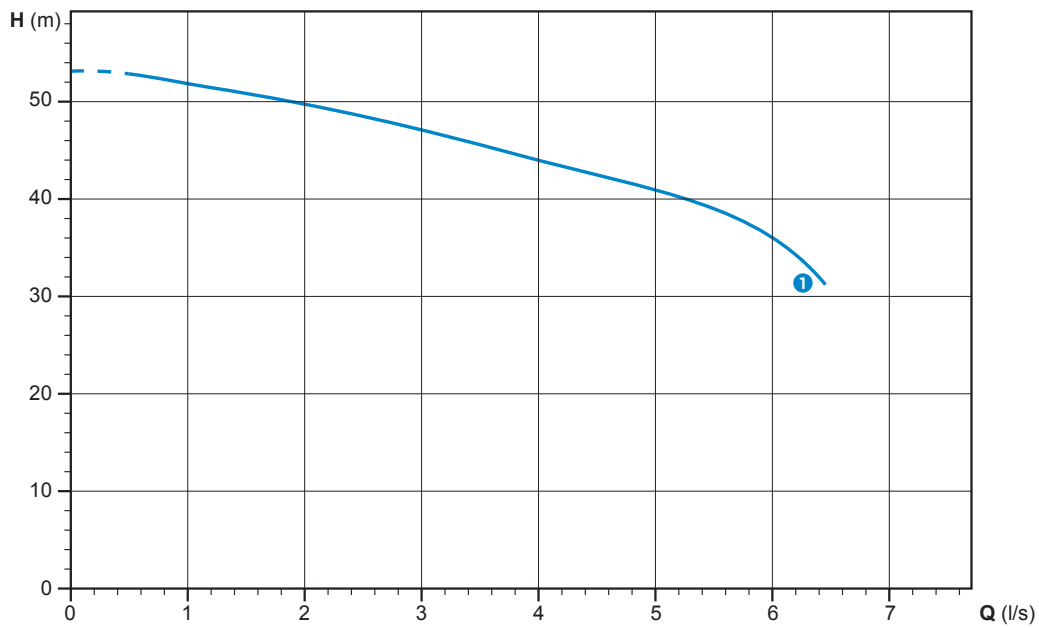



Technical data

	V	Phases	P1 (kW)	P2 (kW)	A	Rpm	Start	Cable	Ø	Free passage
① GRP 750/2/G50H A0HT5	400	3	10.0	7.9	16.04	2900	Y Δ	7G1.5 + 3x0.75	GAS 2"	-

Characteristic curves according to UNI EN ISO 9906

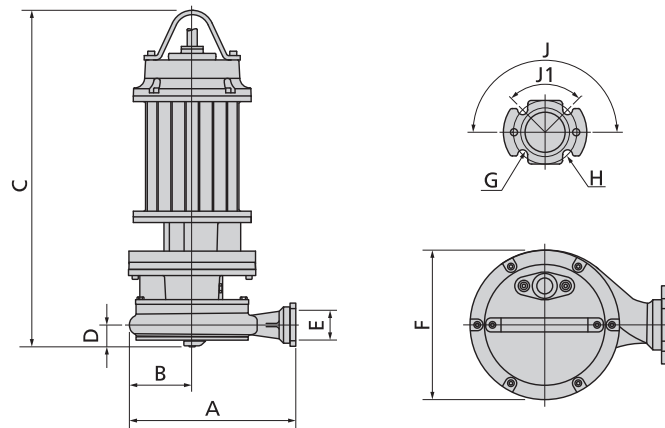
Overall dimensions and weights



	A	B	C	D	E	F	G	H	J	J1	
GRP 750/2/G50H A0HT5	350	130	670	80	G 2"	270	14	90	90°	180°	91

Dimensions in mm

Packaging dimension



	X	Y	Z
GRP 750/2/G50H A0HT5	725	445	415

Dimensions in mm

APP

High head impeller

Operating ranges

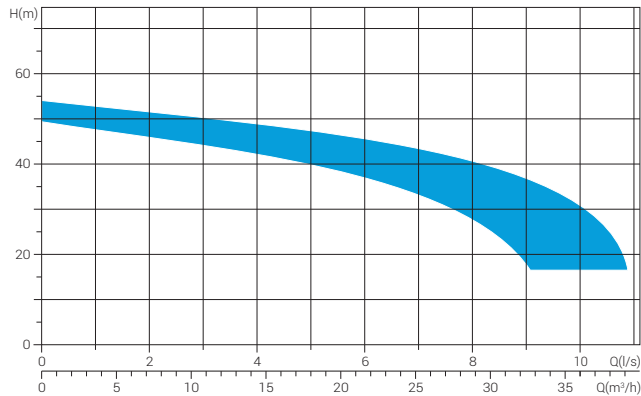

Range characteristics

Motor power	7.2 - 10.0 kW
Poles	2
Insulation class	H
Degree of protection	IP68
Discharge	GAS 2" - DN32 horizontal
Free passage	10 mm
Max flow rate	11.8 l/s
Prevalenza max	58.3 m

Motor

Oil-bath motor with thermal protections.

Cable

S1RN8-F type electrical cable. 10 m standard cable length

Mechanical seals

Two mechanical seals in silicon carbide (2SiC) and one mechanical seal in alumina graphite (AL)

Applications

Used for clear and sandy wastewater, rainwater and seepage. The considerable manometric head guarantees excellent results for the creation of water features and decorative fountains; suitable for use in agriculture, irrigation and the fish processing sector.

Installations

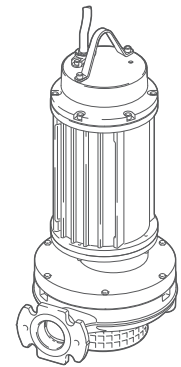
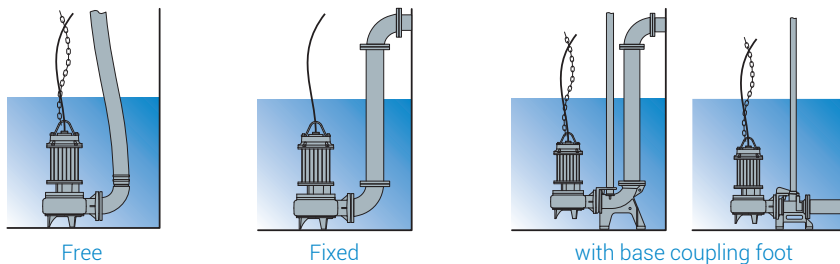

Versions

Electrical variants	T, TS
Cooling system	N
Mechanical seals	2SICAL

Operating specifications

Max operating temperature	40 °C
PH of treated fluid	6 ÷ 14
Viscosity of treated fluid	1 mm²/s
Maximum immersion depth	20 m
Density of treated fluid	1 Kg/dm³
Acoustic pressure max	<70dB
Max starts per hour	20

Construction materials

Case	Cast iron EN-GJL 250
Hydraulic parts	Cast iron EN-GJL 250
Impeller	Cast iron EN-GJL 250
Nuts and bolts	Stainless steel - Class A2-70
Standard gasket	Rubber - NBR
Shaft	Stainless steel - AISI 420
Cutter	Chromium steel
Cooling jacket (optional)	Stainless steel - AISI 304
Paint type	Ecological bicomponent epoxy (~ 150 µm)

APP 2/G50H

Performances

	l/s	0	1	2	3	4	5	6	7	8	9	10
	l/min	0	60	120	180	240	300	360	420	480	540	600
	m ³ /h	0	3.6	7.2	10.8	14.4	18.0	21.6	25.2	28.8	32.4	36.0
① APP 750/2/G50H A0HT5		53.0	51.5	50.0	48.5	46.2	44.0	41.0	38.5	35.8	27.5	
② APP 1000/2/G50H A1HT5		56.0	55.0	53.8	52.0	50.0	48.0	46.0	44.0	40.7	37.0	32.0

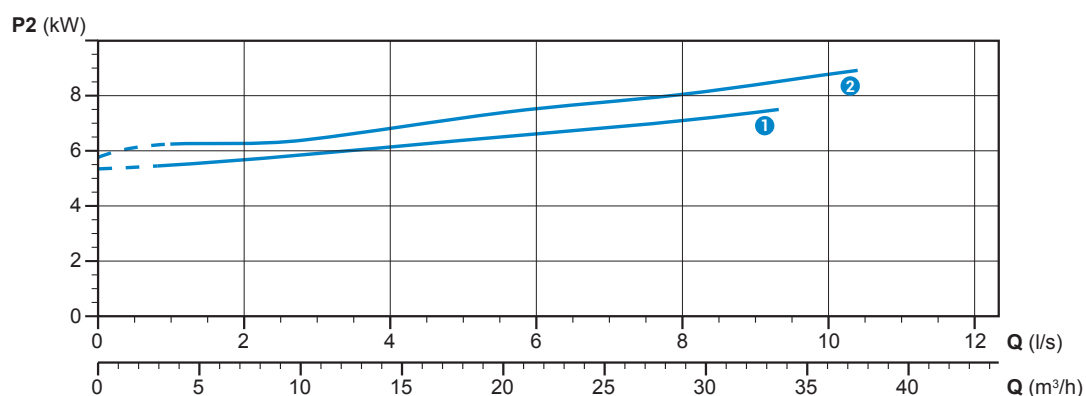
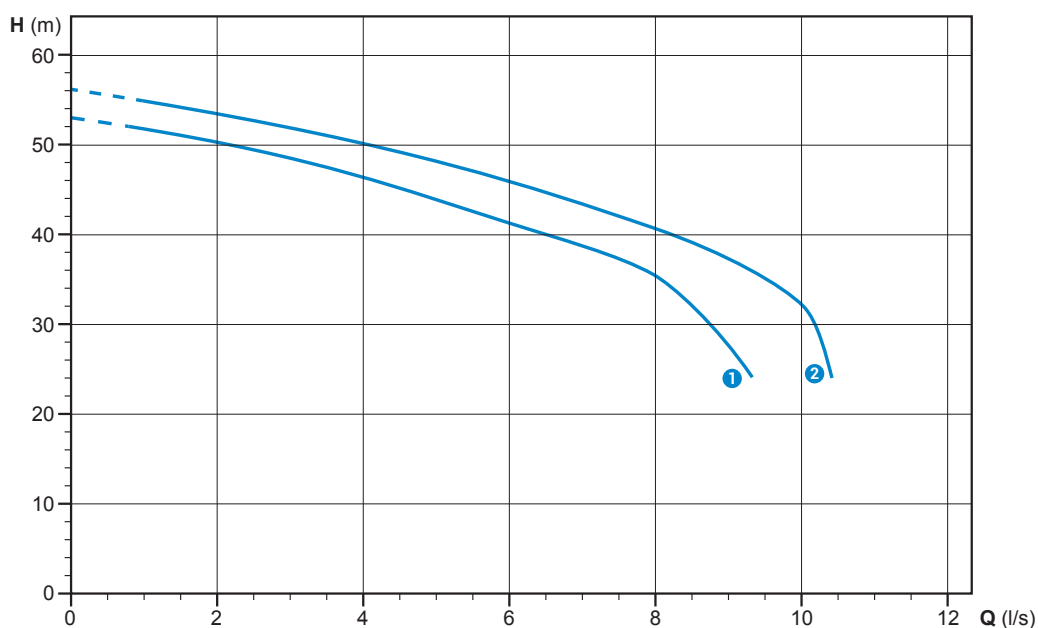

Characteristic curves according to UNI EN ISO 9906

Technical data

	V	Phases	P1 (kW)	P2 (kW)	A	Rpm	Start	Cable	∅	Free passage
① APP 750/2/G50H A0HT5	400	3	10.0	7.9	16.04	2900	Y Δ	7G1.5 + 3x0.75	GAS 2"	10 mm
② APP 1000/2/G50H A1HT5	400	3	13.6	10.8	21.57	2900	Y Δ	7G1.5 + 3x0.75	GAS 2"	10 mm

Overall dimensions and weights

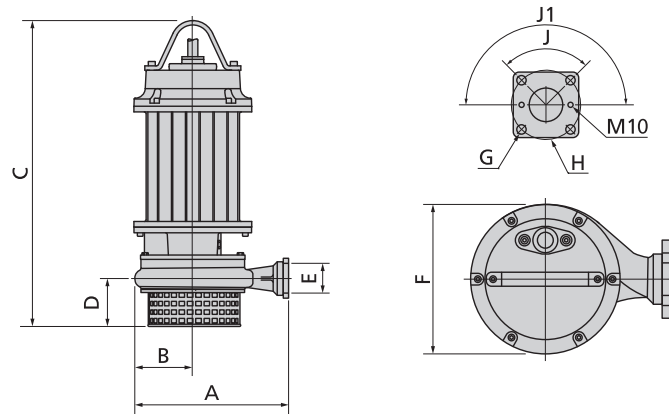

	A	B	C	D	E	F	G	H	J	J1	kg
APP 750/2/G50H A0HT5	355	135	650	45	G 2"	270	17.5	125	90°	180°	90
APP 1000/2/G50H A1HT5	355	135	650	45	G 2"	270	17.5	125	90°	180°	96

Dimensions in mm

Packaging dimension



	X	Y	Z
APP 750/2/G50H A0HT5	725	445	415
APP 1000/2/G50H A1HT5	725	445	415

Dimensions in mm

Multi-channel open impeller with Vulkollan coating

Operating ranges

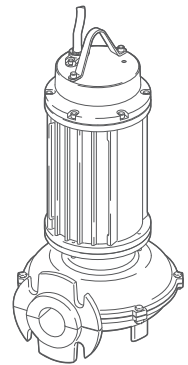
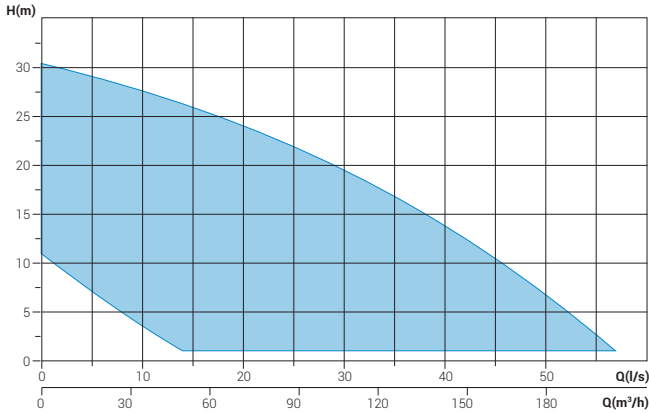

Range characteristics

Motor power	1.5 ÷ 16.4 kW
Poles	2 / 4
Insulation class	H
Degree of protection	IP68
Discharge	DN50 ÷ DN80 horizontal
Free passage	max 54 mm
Max flow rate	49.7 l/s
Prevalenza max	30.7 m

Motor

Oil-bath motor with thermal protections.

Cable

S1RN8-F type electrical cable. 10 m standard cable length.

Mechanical seals

Two mechanical seals in silicon carbide (2SiC) and one mechanical seal in alumina graphite (AL)

Applications

The special coating on the impeller and hydraulic unit makes this electric pump ideal for transferring ceramic glazes or pumping very dense, strongly abrasive liquids.

Installations

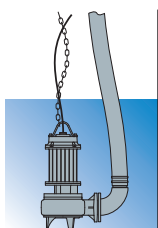

Free

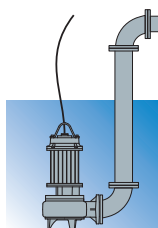

Fixed

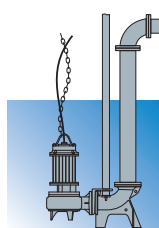

with base coupling foot

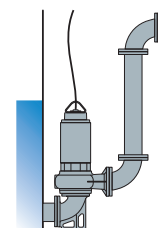
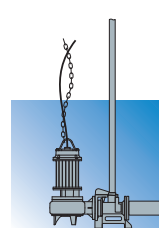

Dry with cooling system

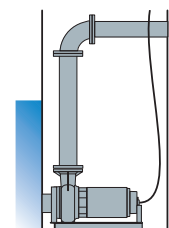

Versions

Electrical variants	T
Cooling system	N, FT, CGFT
Mechanical seals	2SiC/AL

Operating specifications

Max operating temperature	40 °C
PH of treated fluid	6 ÷ 14
Viscosity of treated fluid	1 mm²/s
Maximum immersion depth	20 m
Density of treated fluid	1 Kg/dm³
Acoustic pressure max	<70dB
Max starts per hour	20

Construction materials

Case	Cast iron EN-GJL 250
Hydraulic parts	Cast iron EN-GJL 250
Impeller	Cast iron EN-GJL 250
Nuts and bolts	Stainless steel - Class A2-70
Standard gasket	Rubber - NBR
Shaft	Stainless steel - AISI 420
Cooling jacket (optional)	Stainless steel - AISI 304
Paint type	Ecological bicomponent epoxy (~ 150 µm)

VLP 2/50

Performances

	l/s	0	2	4	6	8	10	12	14	16
	l/min	0	120	240	360	480	600	720	840	960
	m ³ /h	0	7.2	14.4	21.6	28.8	36	43.2	50.4	57.6
①	VLP 400/2/50 A0FT5	22.7	19.5	17.3	15.0	12.5	10.4	8.0	6.0	
②	VLP 550/2/50 A0GT5	25.0	22.5	19.9	17.0	14.0	11.0	7.5	4.4	1.2

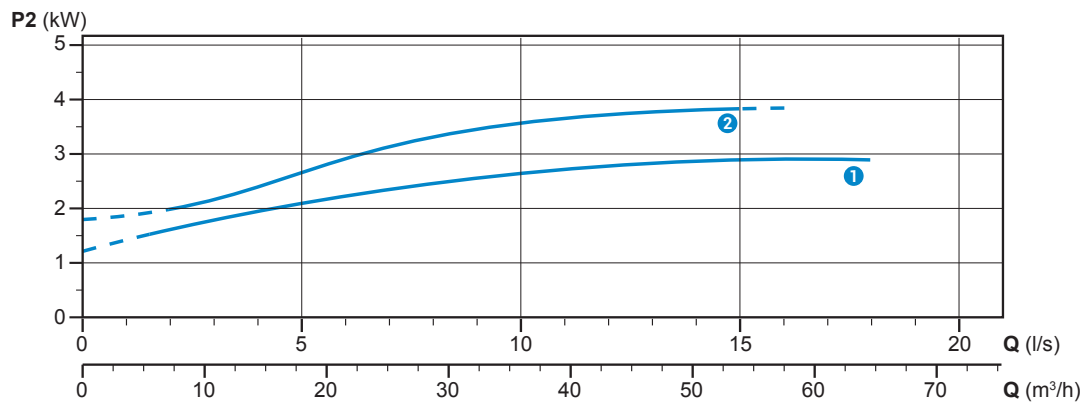
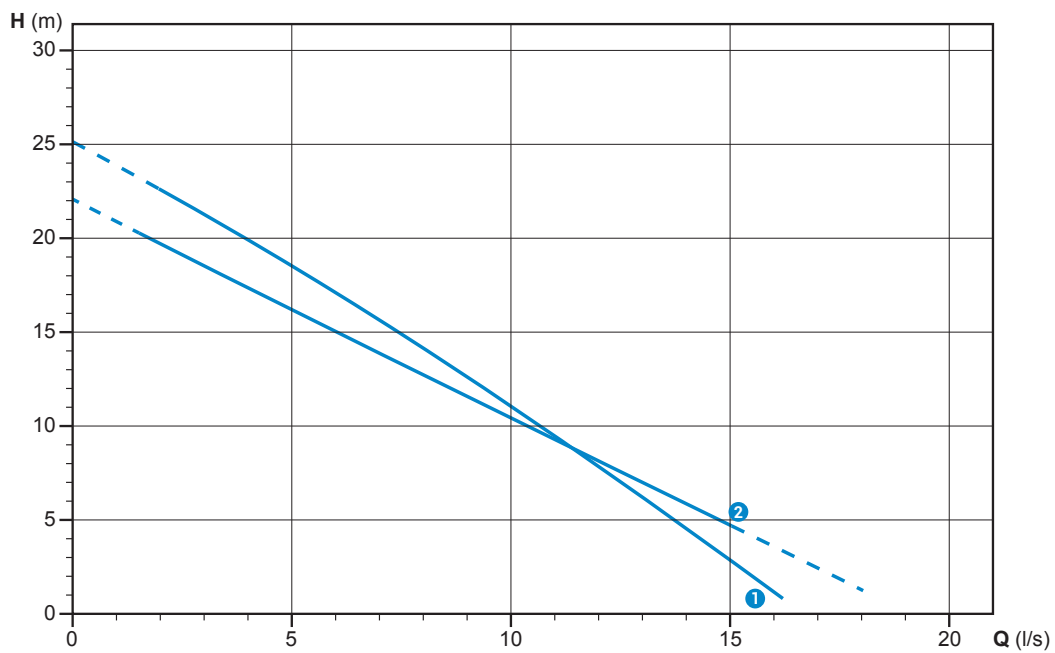

Technical data

	V	Phases	P1 (kW)	P2 (kW)	A	Rpm	Start	Cable	Ø	Free passage
①	400	3	4.66	3.6	8.00	2900	Dir	4G1.5 + 2G1	DN50	25 mm
②	400	3	7.35	5.8	12.06	2900	Dir	4G2.5 + 3x1	DN50	25 mm

Characteristic curves according to UNI EN ISO 9906

VLP 4/50

Performances

	0	2	4	6	8	10	12	14
l/s	0	2	4	6	8	10	12	14
l/min	0	120	240	360	480	600	720	840
m ³ /h	0	7.2	14.4	21.6	28.8	36	43.2	50.4
① VLP 200/4/50 A0ET5	11.7	9.3	7.5	5.6	4.0	2.7	1.7	1.4

Characteristic curves according to UNI EN ISO 9906

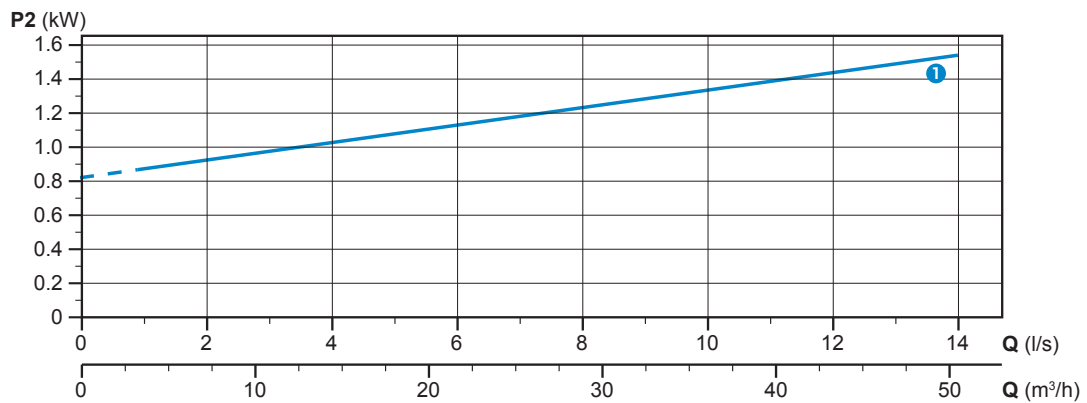
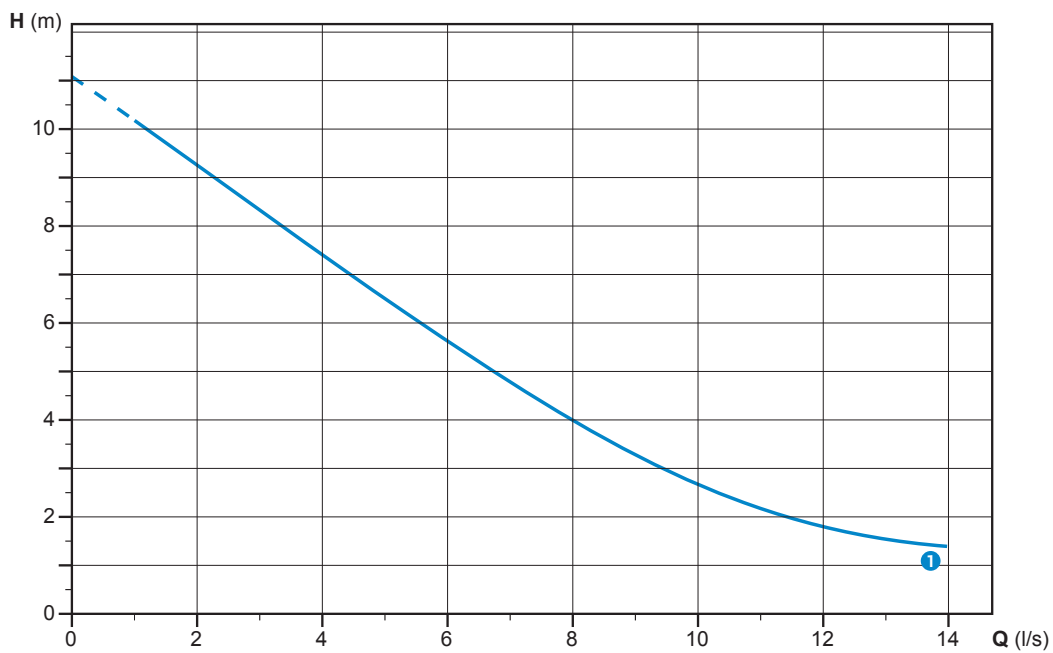

Technical data

	V	Phases	P1 (kW)	P2 (kW)	A	Rpm	Start	Cable	Ø	Free passage
① VLP 200/4/50 A0ET5	400	3	2.13	1.5	4.10	1450	Dir	4G1.5 + 2G1	DN50	28 mm

VLP 4/80

Performances

	l/s	0	4	8	12	16	20	24	28	32	36	40	44	48
	l/min	0	240	480	720	960	1200	1440	1680	1920	2160	2400	2640	2880
	m ³ /h	0	14.4	28.8	43.2	57.6	72	86.4	100.8	115.2	129.6	144	158.4	172.8
① VLP 750/4/80 A0HT5		18.7	15.1	13.2	10.6	8.1	5.5							
② VLP 1000/4/80 A0HT5		21.8	19.0	17.0	14.5	12.4	9.7	6.6						
③ VLP 1500/4/80 A0IT5		25.0	23.8	22.5	21.1	19.5	18.0	16.4	14.4	12.5	10.6	8.8	7.0	5.0
④ VLP 2000/4/80 A0IT5		30.0	28.7	27.6	26.0	24.6	23.2	21.1	19.0	16.5	14.0	11.3	8.5	5.5

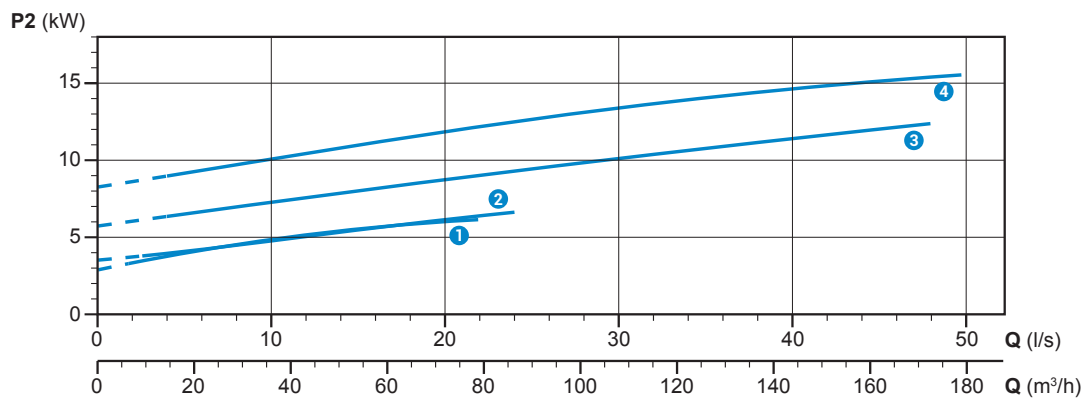
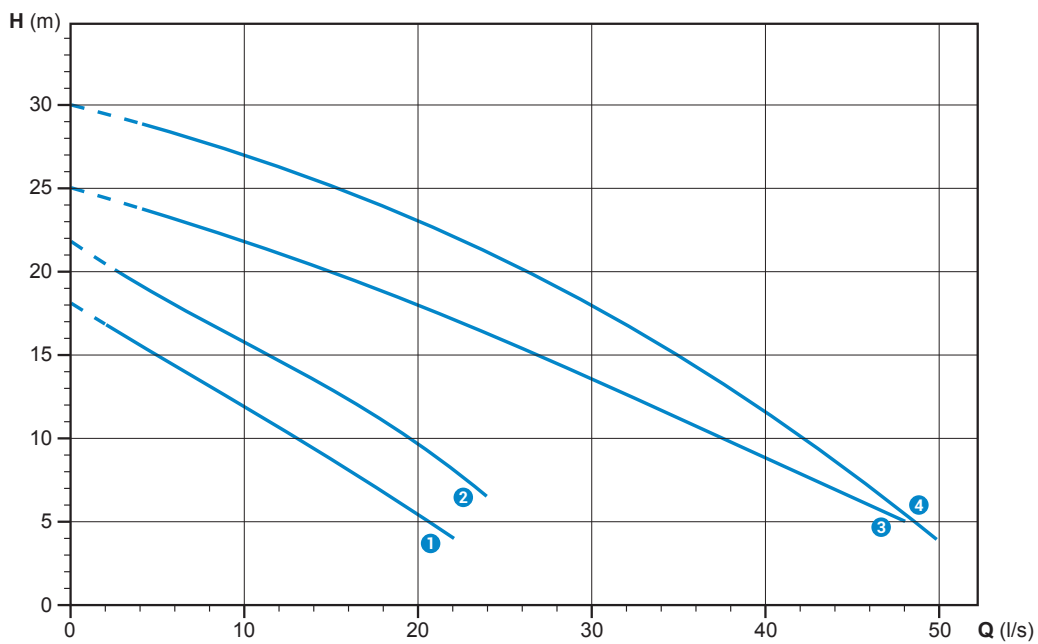

Technical data

	V	Phases	P1 (kW)	P2 (kW)	A	Rpm	Start	Cable	Ø	Free passage
① VLP 750/4/80 A0HT5	400	3	9.1	7.4	15.82	1450	Y Δ	7G1.5 + 3x0.75	DN80	45 mm
② VLP 1000/4/80 A0HT5	400	3	12.8	10.45	21.74	1450	Y Δ	7G1.5 + 3x0.75	DN80	45 mm
③ VLP 1500/4/80 A0IT5	400	3	17.5	14.7	31.18	1450	Y Δ	2x 4G6 + 2G1	DN80	54 mm
④ VLP 2000/4/80 A0IT5	400	3	22.5	18.8	39.60	1450	Y Δ	2x 4G6 + 2G1	DN80	54 mm

Characteristic curves according to UNI EN ISO 9906

Overall dimensions and weights

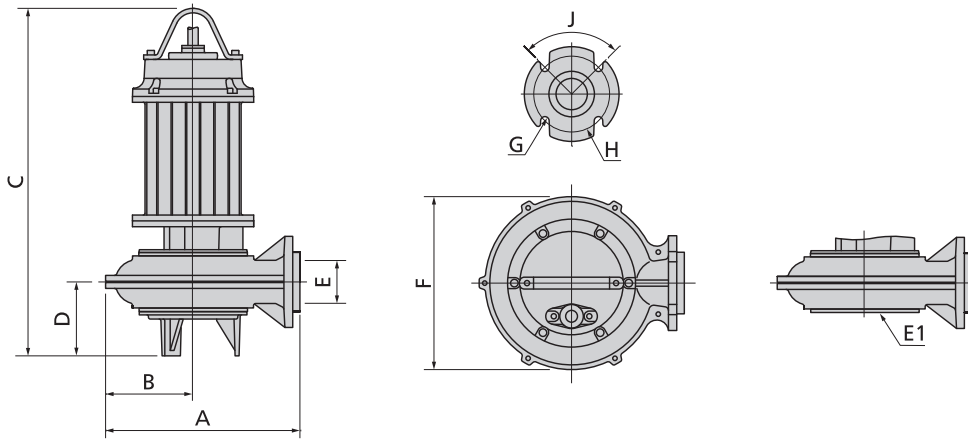

	A	B	C	D	E	E1(*)	F	G	H	J	kg
VLP 400/2/50 A0FT5	290	140	555	105	50	-	260	18	125	90°	48
VLP 550/2/50 A0GT5	290	140	655	105	50	-	260	18	125	90°	67
VLP 200/4/50 A0ET5	290	140	555	105	50	-	260	18	125	90°	26
VLP 750/4/80 A0HT5	435	195	775	165	80	DN150 PN10	365	18	160	90°	80
VLP 1000/4/80 A0HT5	435	195	775	165	80	DN100 PN10	365	18	160	90°	81
VLP 1500/4/80 A0IT5	490	235	970	175	80	-	440	18	160	90°	172
VLP 2000/4/80 A0IT5	490	233	970	175	80	-	440	18	160	90°	190

(*) Suction flange available upon request

Dimensions in mm

Packaging dimension



	X	Y	Z
VLP 400/2/50 A0FT5	725	445	415
VLP 550/2/50 A0GT5	725	445	415
VLP 200/4/50 A0ET5	725	445	415
VLP 750/4/80 A0HT5	915	515	555
VLP 1000/4/80 A0HT5	915	515	555
VLP 1500/4/80 A0IT5	915	515	555
VLP 2000/4/80 A0IT5	915	515	555

Dimensions in mm

Hydraulic performance data

DGP

	l/s	0	8	16	24	32	40	48	56	64	72	80	88	96
	l/min	0	480	960	1440	1920	2400	2880	3360	3840	4320	4800	5280	5760
	m ³ /h	0	28.8	57.6	86.4	115.2	144	172.8	201.6	230.4	259.2	288	316.8	345.6
DGP 550/4/80 A0GT5		11.8	10.6	9.0	6.6	3.3								
DGP 750/4/80 A0HT5		14.2	13.5	11.8	9.2	6.0								
DGP 1000/4/80 A0HT5		17.1	16.0	14.8	13.5	11.1	8.6	5.5						
DGP 550/4/100 A0GT5		10	9.15	8	6.5	4.9	3.0							
DGP 750/4/100 A0HT5		9.6	9.2	8.2	6.8	5.4	3.9							
DGP 1000/4/100 A0HT5		11.4	11	10.2	9.1	7.8	6.1							
DGP 1500/4/100 A0IT5		16.1	15.4	14.5	13.6	12.4	10.8							
DGP 1000/4/125 A0HT5		8.8	8.9	8.8	8.6	8.0	7.0	6.2	5.4	4.2	3.4			
DGP 1500/4/125 A0IT5		10.2	10.4	10.2	9.9	9.4	8.6	7.8	6.9	6.0	5.0	4.1		
DGP 2000/4/125 A0IT5		14.1	14.1	13.9	13.5	13.0	12.1	11.1	10.1	9.0	8.0	7.1	6.0	4.7

DRP

	l/s	0	10	20	30	40	50	60	70	80	90	100	110	120	130	140
	l/min	0	600	1200	1800	2400	3000	3600	4200	4800	5400	6000	6600	7200	7800	8400
	m ³ /h	0	36	72	108	144	180	216	252	288	324	360	396	432	468	504
DRP 750/2/80 A0HT5		24	19.8	14.7	9.1	3.3										
DRP 1000/2/80 A1HT5		30	26.1	21.8	16.8	10.8										
DRP 1500/2/80 A0HT5		40.8	36.5	31.8	25.4	18.0										
DRP 2000/2/80 A0IT5		48.0	44.7	40.8	34.3	23.9										
DRP 1000/2/100 A1HT5		25.1	22.0	18.1	14.6	10.8	6.5	2.1								
DRP 1500/2/100 A0HT5		34.0	31.0	27.6	24.0	20.1	16.0	10.8								
DRP 550/4/80 A0GT5		14.0	11.5	8.9	5.3	1.0										
DRP 750/4/80 A0HT5		18.7	17.0	14.5	11.2	6.7	2.0									
DRP 1000/4/80 A0HT5		23.4	20.6	17.6	14.4	10.8	6.1									
DRP 1500/4/80 A0IT5		29.6	27.2	25.7	23.5	20.8	16.1									
DRP 2000/4/80 A0IT5		32.5	29.8	27.7	24.7	20.4										
DRP 550/4/100 A0GT5		12.9	11.0	9.0	7.0	4.2	1.5									
DRP 750/4/100 A0HT5		16.0	14.4	13.0	11.1	9.0	6.4	3.3								
DRP 1000/4/100 A0HT5		19.1	17.8	16.2	14.2	12.0	9.5	6.7	3.5							
DRP 1500/4/100 A0IT5		21.6	20.5	19.2	17.8	15.8	13.4	10.6	7.5							
DRP 1500/4/125 A0IT5		18.0	16.9	15.6	14.3	13.0	11.5	10.0	8.4	7.0	5.5	3.8				
DRP 2000/4/125 A0IT5		21.5	19.8	18.4	17.0	15.6	14.3	13.0	11.9	10.6	9.3	7.9	6.1			
DRP 750/4/150 A0HT5		11.7	10.6	9.7	8.9	8.1	7.2	6.2	5.0	3.8	2.4	1.0				
DRP 1000/4/150 A0HT5		15.0	14.0	12.8	11.9	11.0	10.0	9.0	8.0	6.7	5.4	4.0	2.4			
DRP 1500/4/150 A0IT5		15.5	14.5	13.6	12.8	12.2	11.5	10.5	9.5	8.3	7.2	6.0	4.9	3.6	2.0	
DRP 2000/4/150 A0IT5		18.0	17.0	16.0	15.0	14.5	13.5	13.0	12.2	11.0	9.7	8.5	7.3	6.0	4.4	2.5
DRP 550/6/150 A0HT5		8.0	6.8	5.9	5.4	5.0	4.1	3.3	2.5	1.7	0.7					
DRP 750/6/150 A0HT5		10.0	9.0	8.2	7.6	7.0	6.4	5.6	4.7	3.7	2.2					
DRP 1000/6/150 A0IT5		12.7	11.7	10.8	10.2	9.7	9.0	8.4	7.5	6.4	5.2	4.0				

Hydraulic performance data

SMP	l/s	0	10	20	30	40	50	60	70	80	90	100	110	120	130	140	150
	l/min	0	600	1200	1800	2400	3000	3600	4200	4800	5400	6000	6600	7200	7800	8400	9000
	m ³ /h	0	36	72	108	144	180	216	252	288	324	360	396	432	468	504	540
SMP 550/2/80 A0GT5		31.0	24.0	16.8	8.0												
SMP 750/2/80 A0HT5		35.0	23.5	17.5	10.0												
SMP 1000/2/80 A0HT5		39.0	29.5	22.5	13.8												
SMP 400/4/100 A0FT5		13.5	9.8	8.0	6.0	3.5											
SMP 750/4/100 A0HT5		19.1	14.9	12.7	11.1	9.5	7.5	5.3									
SMP 1000/4/100 A0HT5		22.5	18.4	16.5	14.0	12.0	9.0	5.8									
SMP 400/4/150 A0FT5		13.2	9.5	8.0	6.5	4.2	1.8										
SMP 750/4/150 A0HT5		18.5	14.7	12.5	11.0	9.5	7.4	5.0									
SMP 1000/4/150 A0HT5		22.4	18.2	16.4	14.7	12.5	10.1	7.6	4.0								
SMP 1500/4/150 A0IT5		24.1	20.5	18.0	16.4	15.2	14.0	12.8	11.0	9.1	7.6	6.0	3.9	2.0			
SMP 2000/4/150 A0IT5		29.2	26.0	23.2	21.0	19.1	17.8	16.5	15.0	13.5	11.8	9.9	8.0	6.4	4.0	2.0	
SMP 2000/4/200 A0IT5		29.0	25.4	22.5	20.4	19.0	17.4	16.2	14.9	13.6	12.2	10.8	9.0	7.8	5.9	4.0	
SMP 750/6/200 A0HT5		15.0	12.6	11.1	10.2	9.2	8.3	7.5	6.3	5.5	4.3	3.0	1.8	0.3			
SMP 2000/4/250 A0IT5		27.3	24	21.5	19.5	18.0	16.7	15.7	14.7	13.7	12.5	11.3	9.8	8.4	6.7	5.0	3.3
SMP 750/6/250 A0HT5		14.1	11.9	10.6	9.7	9.0	8.2	7.5	6.5	5.8	4.6	3.6	2.3	1.0			

SBP	l/s	0	20	40	60	80	100	120	140	160	180	200	220
	l/min	0	1200	2400	3600	4800	6000	7200	8400	9600	10800	12000	13200
	m ³ /h	0	72	144	216	288	360	432	504	576	648	720	792
SBP 750/2/80 A0HT5		34.0	22.0										
SBP 750/4/150 A0HT5		17.6	13.9	10.5	6.5								
SBP 1000/4/150 A0HT5		21.5	17.2	13.4	9.4	3.2							
SBP 1000/6/200 A0IT5		10.5	9.5	8.4	7.2	5.8	4.5	3.0	1.4				
SBP 1500/6/200 A1IT5		14.8	12.8	11.6	10.6	9.8	8.7	7.5	6.0	4.5	2.8		
SBP 1000/6/250 C0IT5		10.7	9.2	8.2	7.4	6.5	5.4	4.1	2.6	1.0			
SBP 1500/6/250 A1IT5		14.5	12.3	11.2	10.5	9.7	9.0	7.8	6.7	5.4	4.2	3.0	1.8

GRP	l/s	0	1	2	3	4	5	6
	l/min	0	60	120	180	240	300	360
	m ³ /h	0	3.6	7.2	10.8	14.4	18	21.6
GRP 750/2/G50H A0HT5		53.5	52.0	49.5	47.5	44.0	40.8	36.0

APP	l/s	0	1	2	3	4	5	6	7	8	9	10
	l/min	0	60	120	180	240	300	360	420	480	540	600
	m ³ /h	0	3.6	7.2	10.8	14.4	18.0	21.6	25.2	28.8	32.4	36.0
APP 750/2/G50H A0HT5		53.0	51.5	50.0	48.5	46.2	44.0	41.0	38.5	35.8	27.5	
APP 1000/2/G50H A1HT5		56.0	55.0	53.8	52.0	50.0	48.0	46.0	44.0	40.7	37.0	32.0

Hydraulic performance data

VLP	l/s	0	4	8	12	16	20	24	28	32	36	40	44	48
	l/min	0	240	480	720	960	1200	1440	1680	1920	2160	2400	2640	2880
	m ³ /h	0	14.4	28.8	43.2	57.6	72	86.4	100.8	115.2	129.6	144	158.4	172.8
VLP 400/2/50 A0FT5		22.1	17.3	12.5	8.0									
VLP 550/2/50 A0GT5		25.0	19.9	14.0	7.5	1.2								
VLP 200/4/50 A0ET5		11.1	7.5	4.0	1.7									
VLP 750/4/80 A0HT5		18.1	15.1	13.2	10.6	8.1	5.5							
VLP 1000/4/80 A0HT5		21.8	19.0	17.0	14.5	12.4	9.7	6.6						
VLP 1500/4/80 A0IT5		25.0	23.8	22.5	21.1	19.5	18.0	16.4	14.4	12.5	10.6	8.8	7.0	5.0
VLP 2000/4/80 A0IT5		30.0	28.7	27.6	26.0	24.6	23.2	21.1	19.0	16.5	14.0	11.3	8.5	5.5



water solutions

All data made available remain non-binding. Zenit reserves the right to make unannounced product changes it deems appropriate

Rev. 1 - 01/09/16