

B

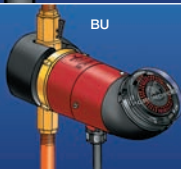

BT



BU

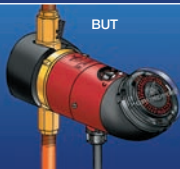

BUT



BX



BXT

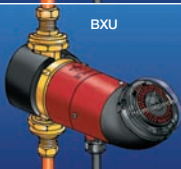

BXU

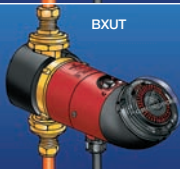

BXUT

## Grundfos Comfort

<b>GB</b>	Grundfos declares that these products are in conformity with the following EU directives:	Grundfos izjavlja, da so ti izdelki v skladu z naslednjimi smernicami EU:	<b>SI</b>
<b>D</b>	Konformitätserklärung. Grundfos erklärt, daß diese Produkte mit den folgenden EU-Richtlinien übereinstimmen:	Grundfos izjavlja da su ovi proizvodi sukladni slijedećim smjernicama EU:	<b>HR</b>
<b>F</b>	Grundfos déclare que ces produits sont en conformité avec les directives de l'Union Européenne suivantes:	Grundfos izjavlja da su ovi proizvodi u saglasnosti sa sledećim smernicama EU:	<b>YU</b>
<b>I</b>	Grundfos dichiara che questi prodotti sono conformi alle seguenti Direttive della Comunità Europea:	Societatea Grundfos declară că aceste produse sunt în conformitate cu următoarele directive ale Uniunii Europene:	<b>RO</b>
<b>E</b>	Grundfos declara que estos productos son conformes con las siguientes Directivas Europeas:	Грундфос потврђува да че тези производи соотвeтстват на следващите директиви на EC:	<b>BG</b>
<b>P</b>	A Grundfos declara que estes produtos estão em conformidade com as seguintes directivas UE:	Firma Grundfos prohlašuje, že výrobky jsou v souladu s následujícími směrnicemi EU:	<b>CZ</b>
<b>GR</b>	Η Grundfos δηλώνει ότι τα προϊόντα αυτά συμμορφώνονται προς τις ακόλουθες οδηγίες της Ε.Ε.:	Firma Grundfos prehlasuje, že výrobky sú v súlade s nasledovnými smernicami EU:	<b>SK</b>
<b>NL</b>	Grundfos verklaart, dat deze producten in overeenstemming zijn met de volgende richtlijnen:	Grundfos bu ürünlerin Avrupa Birliği'nin aşağıdaki Direktiflerine uygunluğunu onaylar:	<b>TR</b>
<b>S</b>	Grundfos försäkrar att dessa produkter är i överensstämmelse med följande EU-direktiv:	Grundfos kinnitab, et antud tooted vastavad järgmistele EU normidele:	<b>EE</b>
<b>SF</b>	Grundfos vakuuttaa, että nämä tuotteet täyttävät seuraavien EU direktiivien vaatimukset:	Firma Grundfos paziņo, ka izstrādājumi atbilst sekojošām ES normām:	<b>LV</b>
<b>DK</b>	Grundfos erklærer, at disse produkter er i overensstemmelse med følgende EU direktiver:	Grundfos patvirtina, kad šie produktai atitinka žemiau išvardintas ES normas:	<b>LT</b>
<b>PL</b>	Firma Grundfos oświadcza, że dane wyroby są zgodne z niniejszymi wytycznymi UE:	98/37/EEC (EN 292) 89/336/EEC (EN 50 081-1, EN 50 082-2) 73/23/EEC (EN 60 335-1, EN 60 335-2-51)	
<b>RU</b>	Фирма Grundfos заявляет, что данные изделия отвечают следующим нормам EC:	Bjerringbro, 1st November 2000 	
<b>H</b>	Mi, a Grundfos kijelentjük, hogy ezen termékek megfelelnek az Európai Unió következő irányelveinek:	Svend Aage Kaae Technical Manager	

H max. = 1.2 [ m ]

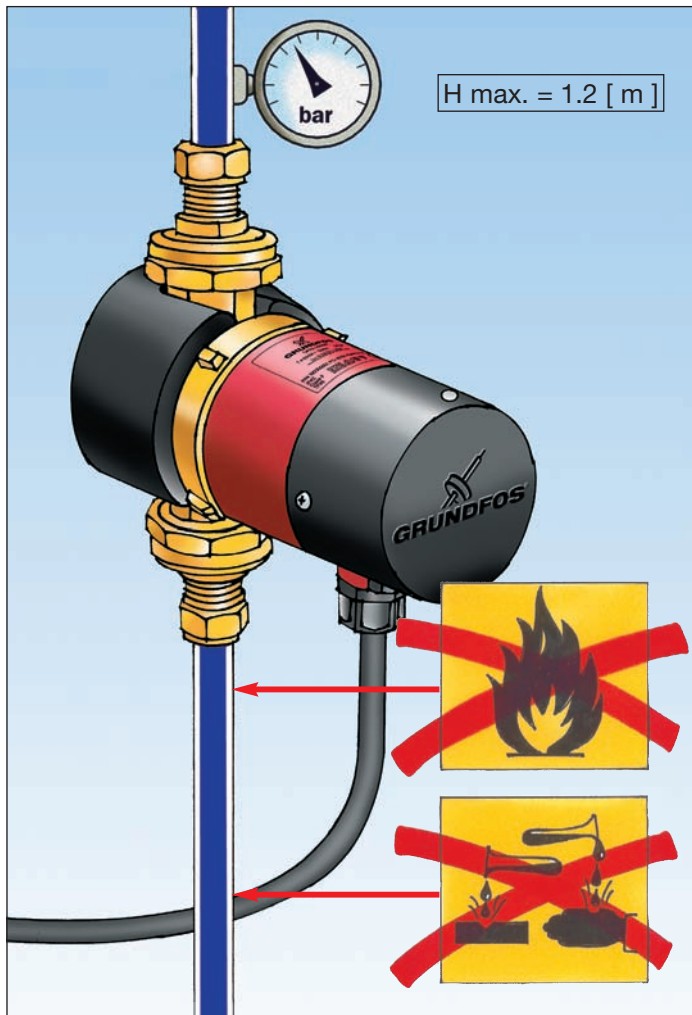

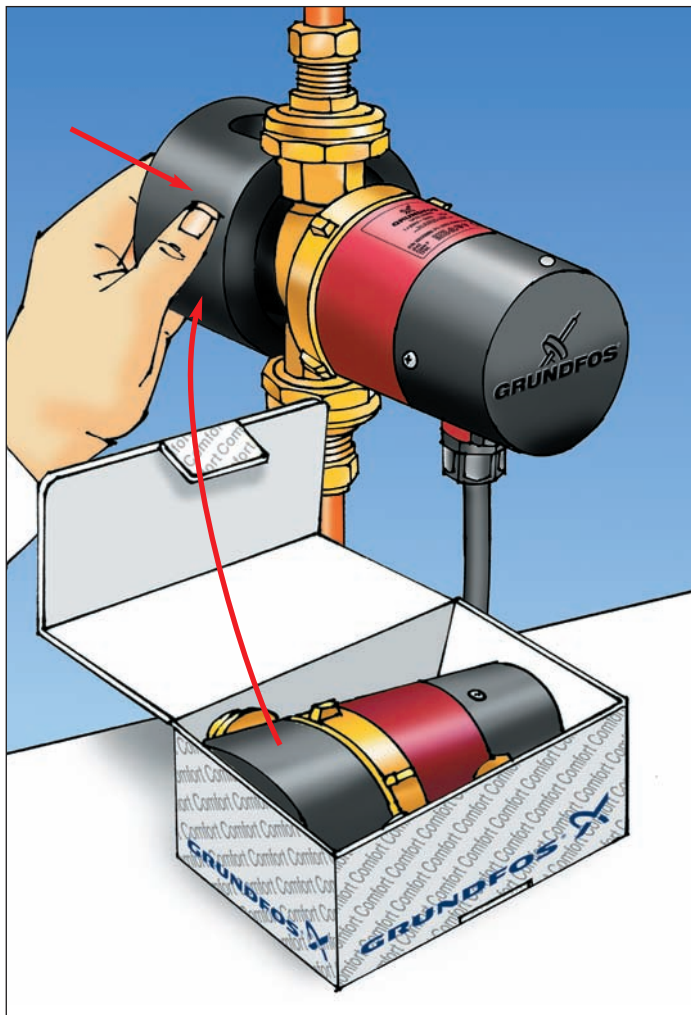

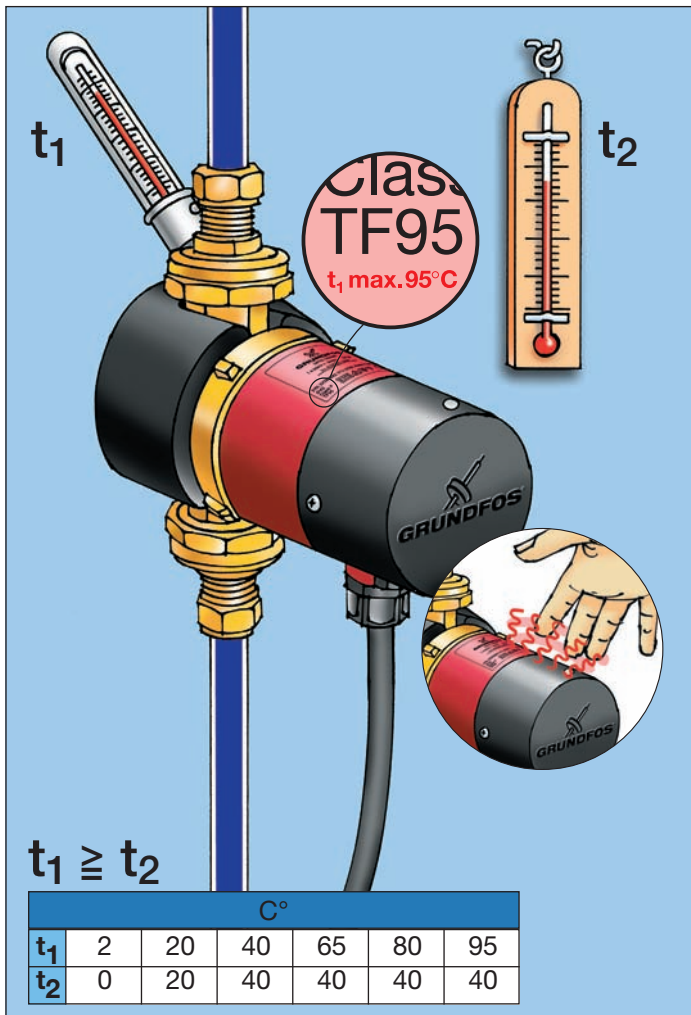

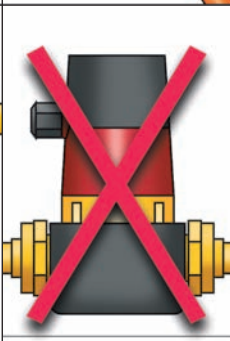
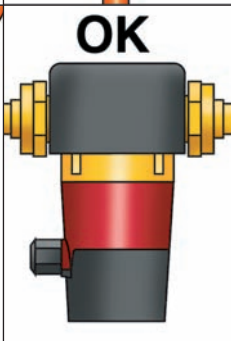
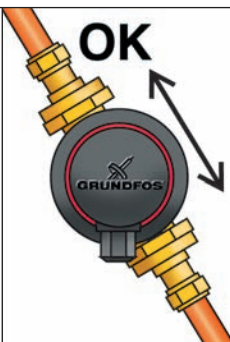
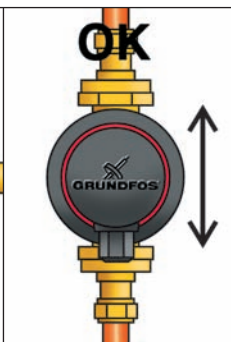
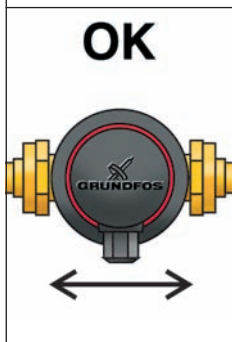
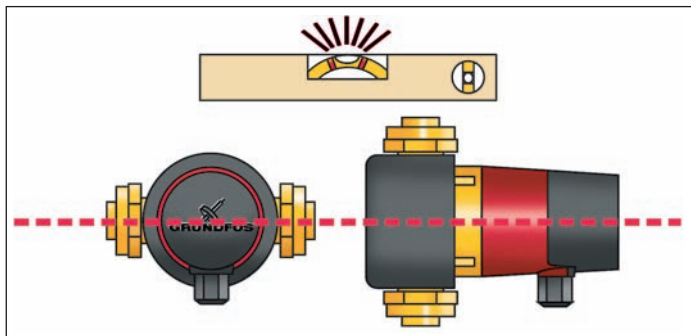

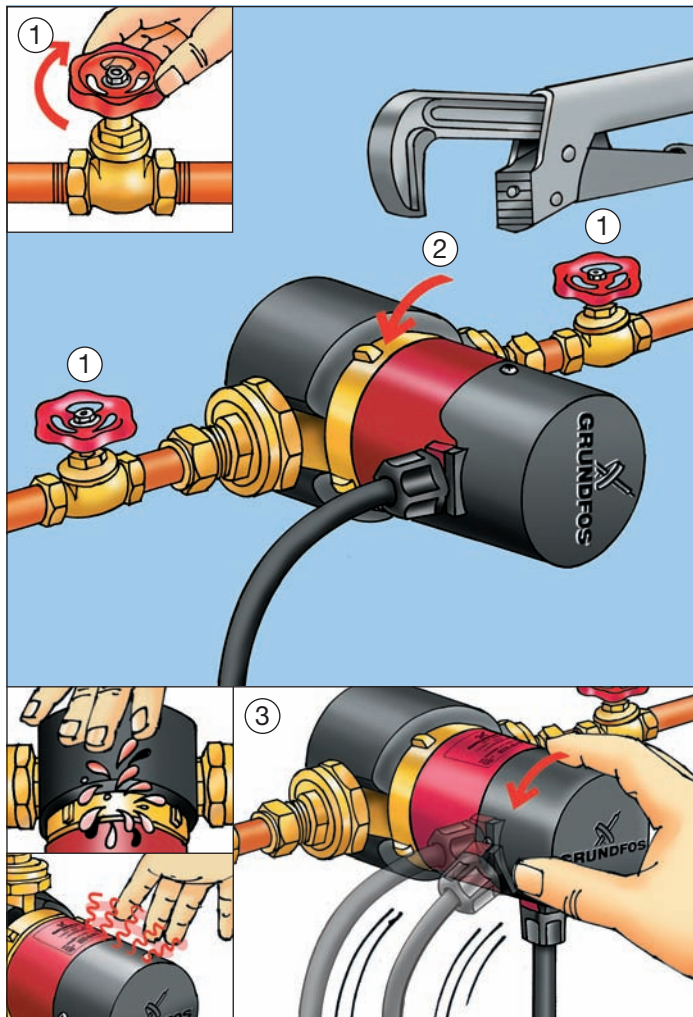

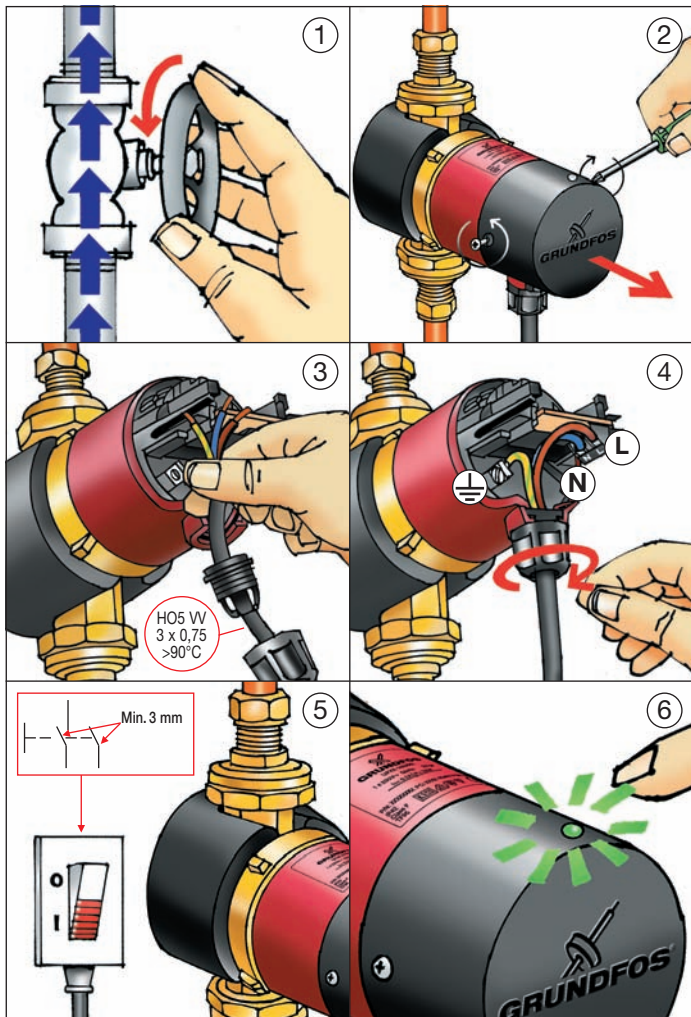



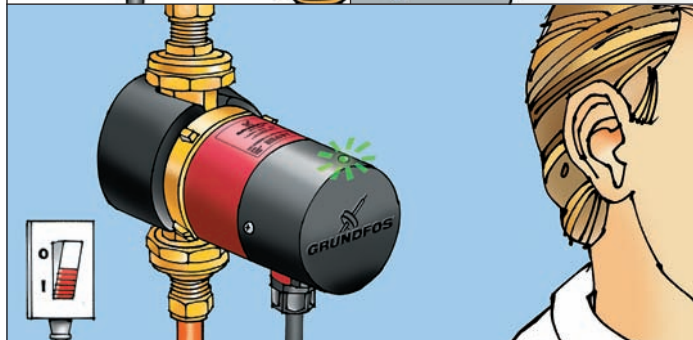

B(X) → B(X)U  
B(X)T → B(X)UT

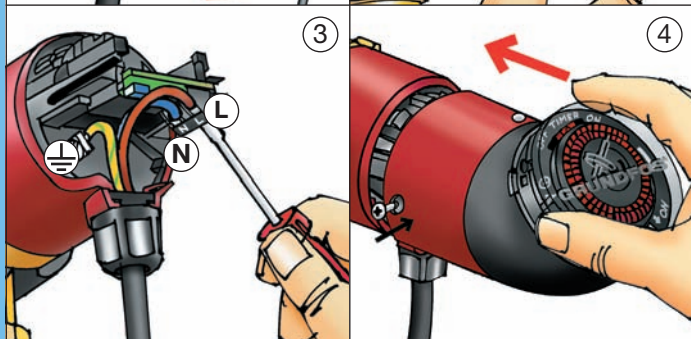
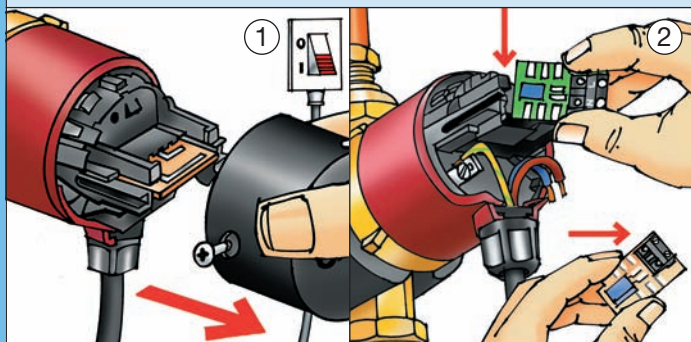
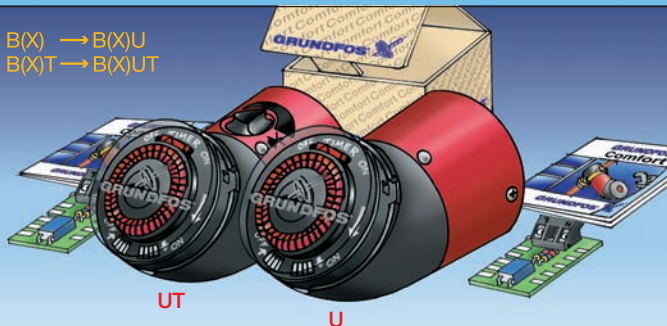

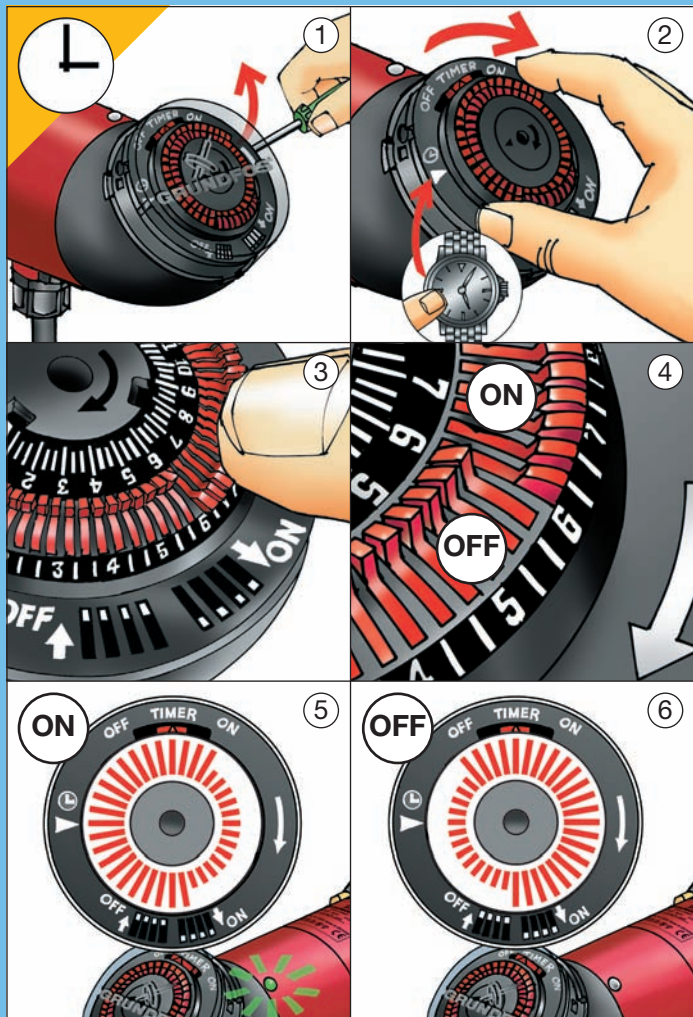

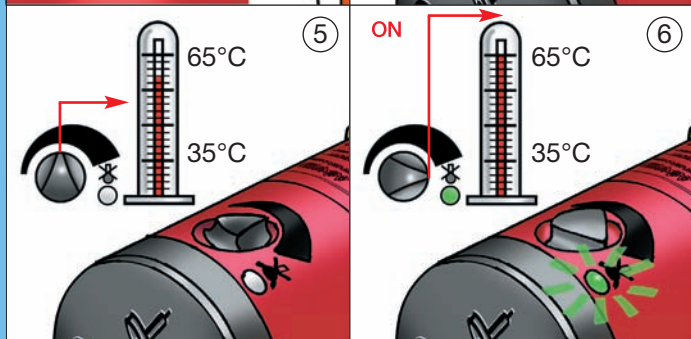
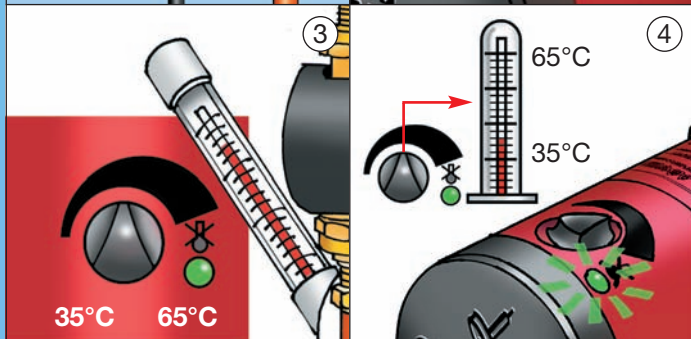
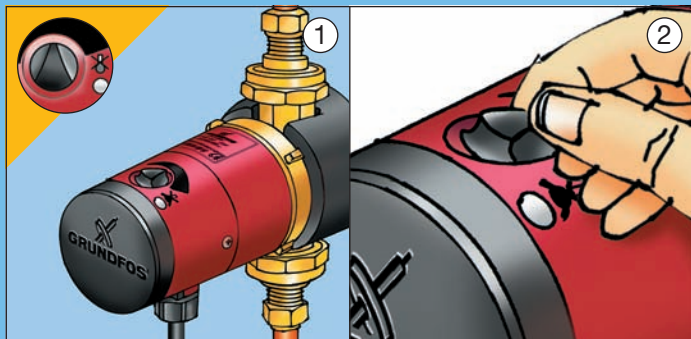

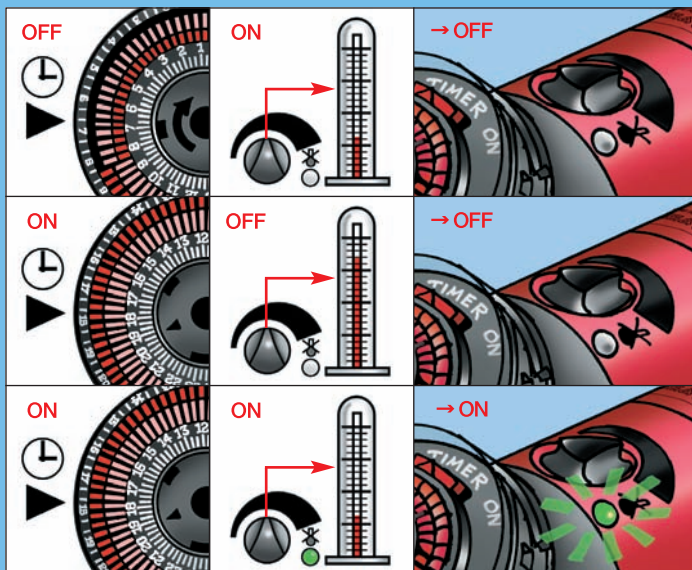
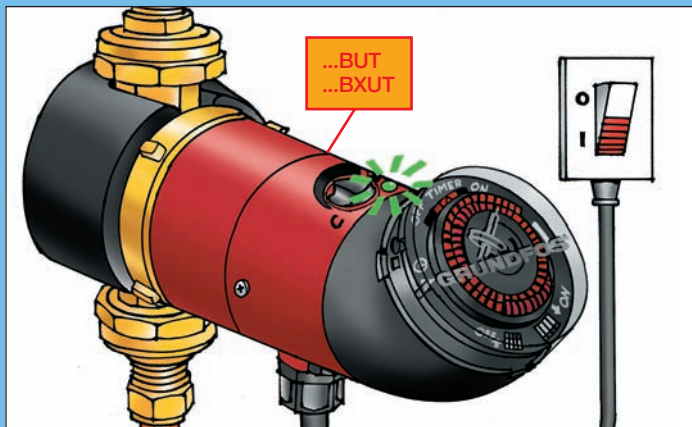

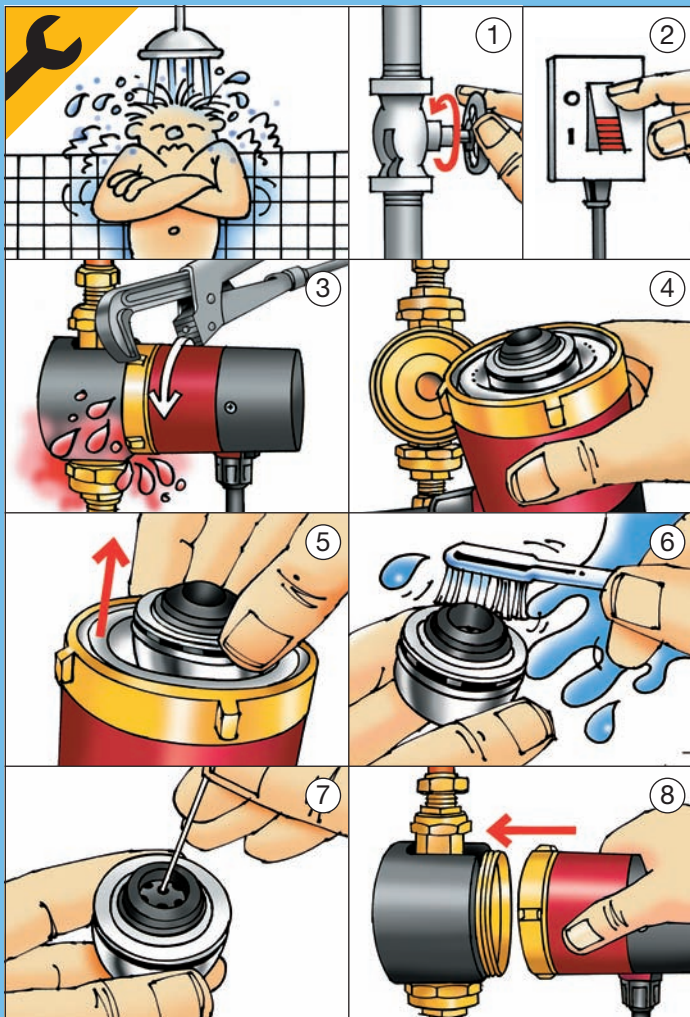



**Poziom ciśnienia akustycznego**  
Poziom ciśnienia akustycznego pompy nie przekracza 43 dB(A).

PL

**Уровень шума**  
Уровень шума насоса не превышает 43 дБ(А).

RU

**Zajszint**  
A szivattyú zajszintje alacsonyabb, mint 43 dB(A).

H

**Nivo hrupnosti**  
Nivo hrupnosti leži pod 43 dB(A).

SI

**GB** **Sound pressure level**  
The sound pressure level of the pump is lower than 43 dB(A).

**D** **Schalldruckpegel**  
Der Schalldruckpegel der Pumpe liegt unter 43 dB(A).

**Razina zvučnog tlaka**  
Razina zvučnog tlaka crpke leži ispod 43 dB(A).

HR

**F** **Niveau de pression acoustique**  
Le niveau de pression acoustique du circulateur est inférieur à 43 dB(A).

**Nivo zvučnih pritisaka**  
Nivo zvučnog pritiska pumpe ispod 43 dB(A).

YU

**I** **Livello di rumorosità**  
Il livello di pressione sonora della pompa è inferiore a 43 dB(A).

**Nivelul sonor**  
Nivelul de zgomot al pompei este mai mic de 43 dB(A).

RO

**E** **Nivel de ruido**  
El nivel de ruido de la bomba es inferior a 43 dB(A).

**Ниво на шума**  
Нивото на шум на помпата е под 43 дБ(А).

BG

**P** **Nível de pressão sonora**  
O nível de pressão sonora produzido pelo circulador é inferior a 43 dB(A).

**Akustický tlak**  
Hladina akustického tlaku je pod hranicí 43 dB(A).

CZ

**GR** **Στάθμη ηχητικής πίεσης**  
Η στάθμη ηχητικής πίεσης του κυκλοφορητή είναι χαμηλότερη από 43 dB(A).

**Akustický tlak**  
Hladina akustického tlaku je pod hranicou 43 dB(A).

SK

**NL** **Geluidsdrukniveau**  
Het geluidsdrukniveau van de pomp is lager dan 43 dB(A).

**Gürültü seviyesi**  
Pompanın gürültü seviyesi 43 dB(A)'den azdır.

TR

**S** **Ljudtrycksnivå**  
Pumpens ljudtrycksnivå är mindre än 43 dB(A).

**Müratase**  
Pumba müratase ei ületa 43 dB(A).

EE

**SF** **Äänenpainetaso**  
Pumpun äänenpainetaso on alempi kuin 43 dB(A).

**Trokšņu līmenis**  
Sūkņa trokšņu līmenis nepārsniedz 43 dB(A).

LV

**DK** **Lydtryksniveau**  
Pumpens lydtryksniveau er lavere end 43 dB(A).

**Triukšmo lygis**  
Siurblio keliamas triukšmas neviršija 43 dB(A).

LT

## Replacement

	UP 15 - 14 B		UP 20 - 14 BX	
		BT BU BUT		BXT BXU BXUT
				
<b>PUMPS</b>	<b>L</b>	<b>80</b>	<b>110</b>	
<b>BUDERUS</b>				
BUZ15	80	OK		
BU-Z15A 15C	140	+ 96 43 39 13		
<b>EMB</b>				
NWS 20-6	140	+ 96 43 39 13		
<b>GRUNDFOS</b>				
UP 15-13 B (U)	86	OK		
UP 15-13 BX (U)	130	+ 96 43 39 04		
UP 20-07N, UP 20-15N	150	+ 96 43 39 11		+ 96 43 65 59
<b>KSB</b>				
R12-1E	140	+ 96 43 39 13		
Riotherm C12/15 (T)	150	+ 96 43 39 11		+ 96 43 65 59
<b>LOEWE</b>				
C151 (U)	86	OK		
C151 X (U)	130	+ 96 43 39 04		
<b>SPECK</b>				
BN 20/11, 20/22	150	+ 96 43 39 11		+ 96 43 65 59
<b>VORTEX</b>				
BW(Z) 150, 151 R 1/2"	80	OK		
BW(Z) 152, 153 R 1/2"	80	OK		
BW(Z) 150, 151 V	110			OK
BW(Z) 152, 153 V	110			OK



**UP 15 - 14 B****Product no. 96 43 39 11**

Extension set, Rp 1/2"/G 1 1/4",  
length = 35 mm each

**Product no. 96 43 39 12**

Extension set, Rp 1/2"/G 1 1/2",  
length = 25 mm each

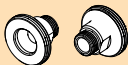
**Product no. 96 43 39 13**

Extension set, Rp 1/2"/G 1",  
length = 30 mm each

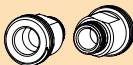
**Product no. 96 43 39 04**

Non-return valve 1/2"

**Product no. 96 43 39 05**

Shut-off-valve 1/2"

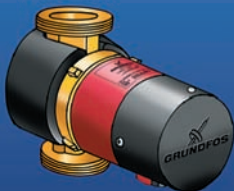
**UP 20 - 14 BX****Product no. 96 43 65 59**

Extension set, Rp 1/4"/G 1 1/4",  
length = 40 mm

**Product no. 96 43 39 07**

Union set, G 1 1/4 x 15 mm  
int./ R 1/2" ext.

**Product no. 96 43 39 08**

Union set, G 1 1/4 x Rp 3/4 int.

**Product no. 96 43 39 09**

Union set, G 1 1/4 int. x Rp 1/2 / R  
3/4 ext.

**Product no. 96 43 39 10**

Union set, G 1 1/4 x 22 mm int.



## Grundfos Comfort user installation

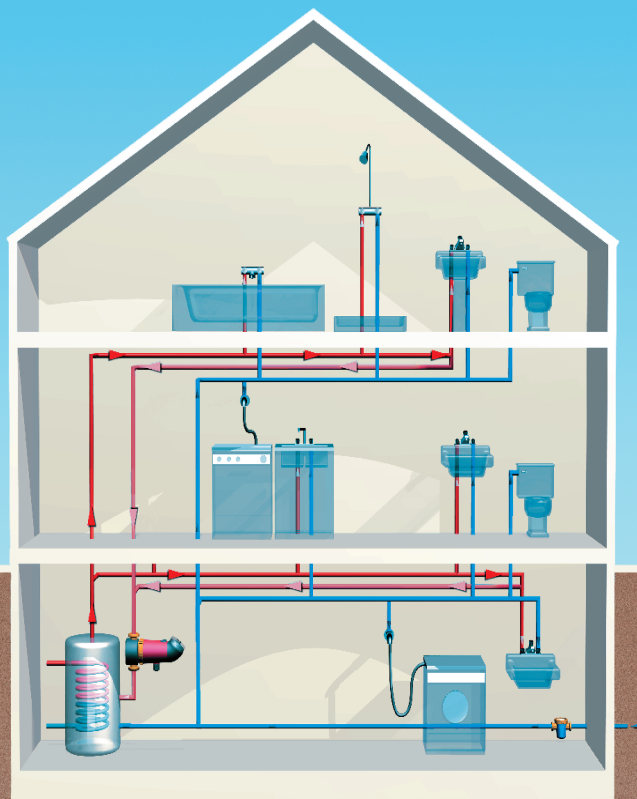

Only **GB**

## Supplementary page for Grundfos Comfort Performance

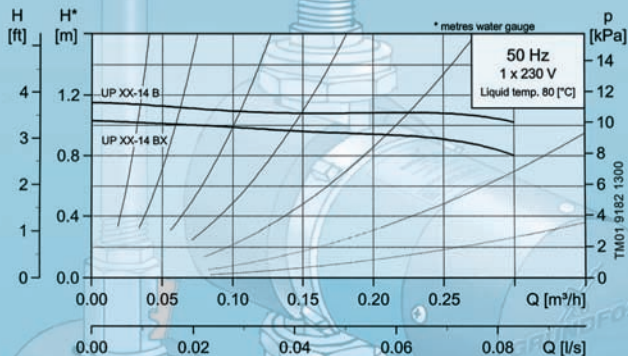

### Recommended applications

Open and closed systems. Domestic hot water systems in single- and two-family houses. Cooling and air-conditioning systems.

### Minimum dynamic head for the inlet water:

Liquid temperature	85°C	95°C
Inlet pressure	0.5 m	2.8 m
	0.049 bar	0.27 bar

**Maximum system pressure:** PN 10, 102 metres water gauge.

**The maximum surface temperature will not exceed 125°C.**

**Do not run the pump without water.**

**Denmark**

GRUNDFOS DK A/S  
Poul Due Jensens Vej 7A  
DK-8850 Bjerningbro  
Tel.: +45-87 50 50 50  
Telefax: +45-87 50 51 51

**Argentina**

Bombas GRUNDFOS de Argentina  
S.A.

Mexico 1404  
(1640) Marínex  
Buenos Aires  
Phone: +54-11-4717 0090  
Telefax: +54-11-4717 1091

**Australia**

GRUNDFOS Pumps Pty. Ltd.  
P.O. Box 2040  
Regency Park  
South Australia 5942  
Phone: +61-8-8461-4611  
Telefax: +61-8-8340 0155

**Austria**

GRUNDFOS Pumpen Vertrieb  
Ges.m.b.H.  
Grundfosstraße 2  
A-5082 Grödig/Salzburg  
Tel.: +43-6246-883-0  
Telefax: +43-6246-883-30

**Belgium**

N.V. GRUNDFOS Bellux S.A.  
Boomsesteenweg 81-83  
B-2630 Aartselaar  
Tel.: +32-3-870 7200  
Telefax: +32-3-870 7301

**Brazil**

GRUNDFOS do Brasil Ltda.  
Rua Tomazina 106  
CEP 83325 - 040  
Pinhal - PR  
Phone: +55-41 668 3555  
Telefax: +55-41 668 3554

**Canada**

GRUNDFOS Canada Inc.  
2941 Brighton Road  
Oakville, Ontario  
L6H 6C9  
Phone: +1-905 829 9533  
Telefax: +1-905 829 9512

**China**

GRUNDFOS Pumps (Shanghai)  
Co. Ltd.  
22 Floor, Xin Hua Lian Building  
755-775 Huai Hai Rd. (M)  
Shanghai 200020  
PRC

Phone: +86-21-64 67 28 09  
Telefax: +86-21-64 67 28 08

**Czech Republic**

GRUNDFOS s.r.o.  
Čajkovského  
779 00 Olomouc  
Phone: +420-68-5716 111  
Telefax: +420-68-543 8908

**Finland**

OY GRUNDFOS Pumpat AB  
Mestarinieki 11  
Pispangkylä  
FIN-01730 Vantaa (Helsinki)  
Phone: +358-9 878 9150  
Telefax: +358-9 878 9150

**France**

Pompes GRUNDFOS Distribution  
S.A.  
Parc d'Activités de Chesnes  
57, rue de Malacombé  
F-38290 St. Quentin Fallavier  
(Lyon)  
Tel.: +33-4 74 82 15 15  
Télécopie: +33-4 74 94 10 51

**Germany**

GRUNDFOS GmbH  
Willy Peltz Straße 1-5  
D-23812 Wahlstedt/Holstein  
Tel.: +49-4554-98-0  
Telefax: +49-4554-98 7399/7355

**Greece**

GRUNDFOS Hellas A.E.B.E.  
20th km. Athinon-Markopoulou Av.  
P.O. Box 71  
GR-19002 Peania  
Phone: +30-1-66 83 400  
Telefax: +30-1-66-46273

**Hong Kong**

Bombas GRUNDFOS of Mexico  
(Hong Kong)  
Ltd.  
Unit 1, Ground floor  
Siu Wai Industrial Centre  
29-33 Wing Hong Street &  
68 King Lam Street, Chung Sha  
Wan  
Kowloon  
Phone: +852-27861706/27861741  
Telefax: +852-27858664

**Hungary**

GRUNDFOS Hungária Kft.  
Park u. 8  
H-2045 Törökbalint,  
Tel.: +36-23 511 110  
Telefax: +36-23 511 111

**India**

GRUNDFOS Pumps India Private  
Limited  
Flat A, Ground Floor  
61/62 Chamiers Aptmt  
Chamiers Road  
Chennai 600 028  
Phone: +91-44 432 3487  
Telefax: +91-44 432 3489

**Indonesia**

PT GRUNDFOS Pompa  
Jl. Rawa Sumur III, Blok III / CC-1  
Kawasan Industri, Pulogadung  
Jakarta 13930  
Phone: +62-21-460 6909  
Telefax: +62-21-460 6910/460 6901

**Ireland**

GRUNDFOS (Ireland) Ltd.  
Unit 34, Stillorgan Industrial Park  
Blackrock  
County Dublin  
Phone: +353-1-2954926  
Telefax: +353-1-2954739

**Italy**

GRUNDFOS Pompe Italia S.r.l.  
Via Gran Sasso 4  
I-20060 Trucuzzano (Milano)  
Tel.: +39-02-9583811/95838212  
Telefax: +39-02-95309290/  
95838461

**Japan**

GRUNDFOS Pumps K.K.  
1-2-3, Shin Miyakoda  
Hamamatsu City  
Shizuoka pref. 431-21  
Phone: +81-53-428 4760  
Telefax: +81-53-484 1014

**Korea**

GRUNDFOS Pumps Korea Ltd.  
2nd Fl., Dong Shin Building  
994-3 Daechi-dong, Kangnam-Ku  
Seoul 135-280  
Phone: +82-2-5317 600  
Telefax: +82-2-5633 725

**Malaysia**

GRUNDFOS Pumps Sdn. Bhd.  
7 Jalan Peguam U1/25  
Glenmarie Industrial Park  
40150 Shah Alam  
Selangor  
Phone: +60-3-5569 2922  
Telefax: +60-3-5569 2866

**Mexico**

Bombas GRUNDFOS de Mexico  
S.A. de C.V.  
Boulevard TLC No. 15  
Parque Industrial Siva Aeropuerto  
Apodaca, N.L. 66600  
Mexico  
Phone: +52-8-144 4000  
Telefax: +52-8-144 4010

**Netherlands**

GRUNDFOS Nederland B.V.  
Pampuslaan 190  
NL-1382 JS Weesp  
Tel.: +31-294-492 211  
Telefax: +31-294-492244/492299

**New Zealand**

GRUNDFOS Pumps NZ Ltd.  
17 Beatrice Tinsley Crescent  
North Harbour Industrial Estate  
Albany, Auckland  
Phone: +64-9-415 3240  
Telefax: +64-9-415 3250

**Norway**

GRUNDFOS Pumper A/S  
Strømsveien 344  
Postboks 235, Leirdal  
N-1011 Oslo  
Tel.: +47-22 90 47 00  
Telefax: +47-22 32 21 50

**Poland**

GRUNDFOS Pompy Sp. z o.o.  
ul. Klonowa 23  
Baranowo k. Poznania  
PL-62-081 Przemierowo  
Phone: +48-61-650 13 00  
Telefax: +48-61-650 13 50

**Portugal**

Bombas GRUNDFOS (Portugal)  
Lda.  
Rua Calvet de Magalhães, 241  
Apartado 1079  
P-2780 Paço de Arcos  
Tel.: +351-21-440 76 00  
Telefax: +351-21-440 76 90

**Russia**

OOO GRUNDFOS-Service Center  
Shkolnaya, ul. 39  
RUS-109544 Moscow  
Phone: +7-095 271 00 00  
Telefax: +7-095 271 09 39

**Singapore**

GRUNDFOS (Singapore) Pte. Ltd.  
24 Tuas West Road  
Jurong Town  
Singapore 638381  
Phone: +65-865 1222  
Telefax: +65-861 8402

**Spain**

Bombas GRUNDFOS España S.A.  
Camino de la Fuentequilla, s/n  
E-28110 Algete (Madrid)  
Tel.: +34-91-848 8800  
Telefax: +34-91-628 0465

**Sweden**

GRUNDFOS AB  
Box 63, Angeredsvägen 9  
S-424 22 Angered  
Tel.: +46-771-32 23 00  
Telefax: +46-31 331 94 60

**Switzerland**

GRUNDFOS Pumpen AG  
Bruggcherstrasse 10  
CH-8117 Fällanden/ZH  
Tel.: +41-1-806 8111  
Telefax: +41-1-806 8115

**Taiwan**

GRUNDFOS Pumps (Taiwan) Ltd.  
14, Min-Yu Road  
Tunglo Industrial Park  
Tunglo, Miao-Li County  
Taiwan, R.O.C.  
Phone: +886-37-98 05 57  
Telefax: +886-37-98 05 70

**Thailand**

GRUNDFOS (Thailand) Ltd.  
947/168 Moo 12, Bangna-Trad Rd.,  
K.M. 3,  
Bangna, Phrakhanong  
Bangkok 10260  
Phone: +66-2-744 1785 ... 91  
Telefax: +66-2-744 1775 ... 6

**Turkey**

GRUNDFOS POMPA SAN. ve TIC.  
LTD. STI  
Bulguru Caddesi no. 32  
TR-81190 Üsküdar İstanbul  
Phone: +90 - 216-4280 306  
Telefax: +90 - 216-3279 988

**United Arab Emirates**

GRUNDFOS Gulf Distribution  
P.O. Box 16788  
Jebel Ali Free Zone  
Dubai  
Phone: +971-4- 8815 166  
Telefax: +971-4-8815 136

**United Kingdom**

GRUNDFOS Pumps Ltd.  
Grovetory Road  
Leighton Buzzard/Beds, LU7 8TL  
Phone: +44-1525-850000  
Telefax: +44-1525-850011

**U.S.A.**

GRUNDFOS Pumps Corporation  
3131 North Business Park Avenue  
Fresno, CA 93727  
Phone: +1-559-292-8000  
Telefax: +1-559-291-1357

6199-130-005

V7 15 81 35 05 01

104

Repl. V7 15 81 35 01 01

Addresses revised 25.04.2001